

# rafbak®



**td TÜRK DEKORASYON**  
Mağaza Dekorasyon ve Teşhir Sistemleri  
[www.turkdekorasyon.com](http://www.turkdekorasyon.com)

**HR HAKAN RAF®**  
Mağaza Ekip.Ahşap Dekorasyon Otomotiv San.Tic.Ltd.Şti

**SÜMBÜL PLASTİK**  
PLASTİK KASA VE KUTULAR

#### Merkez

Çakmak Mah. Alemdağ Cad.  
No:478/480/A  
Ümraniye / İSTANBUL

Tel: 0 216 420 51 37  
0 216 364 78 51  
Faks: 0 216 590 05 28  
Cep Tel: 0 532 414 24 01  
0 532 013 11 65

E-Mail: [hakanraf@gmail.com](mailto:hakanraf@gmail.com)  
[www.hakanraf.com.tr](http://www.hakanraf.com.tr)

#### Fabrika

Ihlamur Kuyu Mahallesi  
Başaran Sokak No:12  
Ümraniye / İstanbul

Cep Tel: 0 555 682 13 18  
0 507 400 25 27  
0 507 400 25 28  
0 532 485 7 RAF  
(7 23)

E-Mail: [hakanraf@gmail.com](mailto:hakanraf@gmail.com)  
[www.hakanraf.com.tr](http://www.hakanraf.com.tr)

#### Şube

Çakmak Mah. Alemdağ Cad.  
No:518/B Ümraniye / İSTANBUL

Tel: 0 216 466 52 90  
Faks: 0 216 590 05 28  
Cep Tel: 0 532 414 24 01  
0 532 013 11 65

E-Mail: [sumbulplastik@gmail.com](mailto:sumbulplastik@gmail.com)  
[www.sumbulplastik.com](http://www.sumbulplastik.com)

**HR HAKAN RAF®**  
Mağaza Ekip.Ahşap Dekorasyon Otomotiv San.Tic.Ltd.Şti

**2022**  
ÜRÜN KATALOĞU



**ASYAMANKEN SÜMBÜL PLASTİK®**  
PLASTİK KASA VE KUTULAR  
[www.asyamanken.com.tr](http://www.asyamanken.com.tr)  
[www.sumbulplastik.com](http://www.sumbulplastik.com)

[www.hakanraf.com.tr](http://www.hakanraf.com.tr)

### Güvenirliliğimizin zedelenmesi yerine zarar etmeyi tercih ederiz.

En önemli ve öncelikli hedefimiz "Güvenilir Olmak"tır. Bugüne kadar ki çalışmalarımızda planlamada, üretim ve teslimat tarihine uygun ve maliyetler üzerine gösterdiğimiz titiz ve kaliteden taviz vermeden davranışımızı, bundan sonraki çalışmalarımızda da göstereceğiz.

### Planlı hareket ederiz.

İçeriği net olarak tanımlamadan, projenin karmaşıklığı ve büyüklüğü karşısında sistematik olarak riskleri tespit etmeden, değerlendirmeden ve gerekli tedbirleri almadan hiçbir projeye başlamayız.

### İşimizi yarım bırakmayız

Kaynaklarımızın kısıtlı olduğu zamanlarda bile yapmamız gereken işin ciddiyetinin bilincindeyiz ve işimizi bitirmeden projeyi teslim etmeyiz.

### Müşteri bizimle aynı masada yer alır.

Biz, müşterimizin parasının karşılığını alabilmesi için; kararlarımızı verirken sanki müşteri adına karar veriyormuş gibi hareket ederiz.

### Sorunları çözmek bizim işimiz.

Özellikle geliştirme alanında, teknik sorunlarla başa çıkabilme, bağ ve bağımlılıkları dikkate alarak düşünmek başarının bir numaralı anahtarıdır.

### Uyarılar çözmek bize yön verir

Muhtemel risk oluşumu ortaya çıkan önemli uyarıları mutlaka dikkate alırız ve kararlarımızı alırken bu riskleri göz önünde bulundururuz.

### Kaliteden taviz vermeyiz.

Müşterilerimize sunduğumuz ürünlerin kaliteli olmasına önem veririz. Ürünlerin kurulumu sırasında da teknoloji destekli hizmet sunarak en yüksek kaliteyi yakalamayı amaçlarız.

### Çalışanlarımızın kıymetini biliriz.

Raflarımızı en ince ayrıntısına kadar tanıyan, aldığımız işi bilgi ve becerisiyle sorunsuz ve zamanında teslim etmemizi sağlayan personelimizin değerini en iyi biz biliriz.

### Tehlikeyi görür ortadan kaldırırız.

Müşterilerimizin raflarında ortaya çıkan problemleri hassasiyetle ele alır ve gereken önlemleri alırız. Bu problemlerin raf güvenliği ile ilgili olması durumunda hemen harekete geçer ve titizlikle konunun üzerine gidip problemi ortadan kaldırırız.

### Doğru ve hedefe yönelik analiz.

Biz karmaşık problemlerle ilgili nedenlerin arayışındayken, detaylarda boğulmadan, çok zaman harcamak pahasına da olsa, doğru ve hedefe yönelik analizleri yapma cesaretine sahibiz.

### 22 yıllık tecrübe

Hakan Raf ailesi olarak ürün çeşidine yönelik çalışmalarımızla depo raf sistemleri, market raf sistemleri, mağaza raf sistemleri, hafif rack sistemleri, mağaza ekipmanları, çelik raf sistemleri, suntalem-ağşap bankolar, camlı dolaplar, soyunma ve dosya dolapları, elektronik raf sistemleri, züccaciye rafları, şarküteri rafları, bujiteri standları, taşıma arabaları, danışma bankoları, kırtasiye raf sistemleri, eczane raf sistemleri, alüminyum camlı standlar gibi birçok raf sistemleri üzerine tasarım ve üretim yapmaktayız. Profesyonel kadromuzla raf sektörü ihtiyaçları doğrultusunda kaliteli iş anlayışı göz önüne alınarak ücretsiz keşif, 3D proje, satış, montaj ve satış sonrası destek hizmeti vermekteyiz.

### MARKET ÜNİTESİ

02-05

### MANAV REYONU ve EKMEK DOLAPLARI

06

### UNLU MAMÜLLER

07

### TURNİKE VE KASA ALTLARI

08-09

### DEPO RAF SİSTEMLERİ (AĞIR RACK)

10-14

### DEPO RAF SİSTEMLERİ (HAFIF RACK)

15-18

### ÇELİK RAF SİSTEMLERİ

19

### BANKO VE TEŞHİR STANDLARI

20-29

### MAĞAZA RAF SİSTEMLERİ

30-38

### KANALLI PANO UYGULAMA

39

### TEŞHİR STANDLARI

40-44

### VİTRİN MANKENLERİ

45

### AKSESUARLAR

46-47

### SOYUNMA VE DOSYA DOLAPLARI

48-49

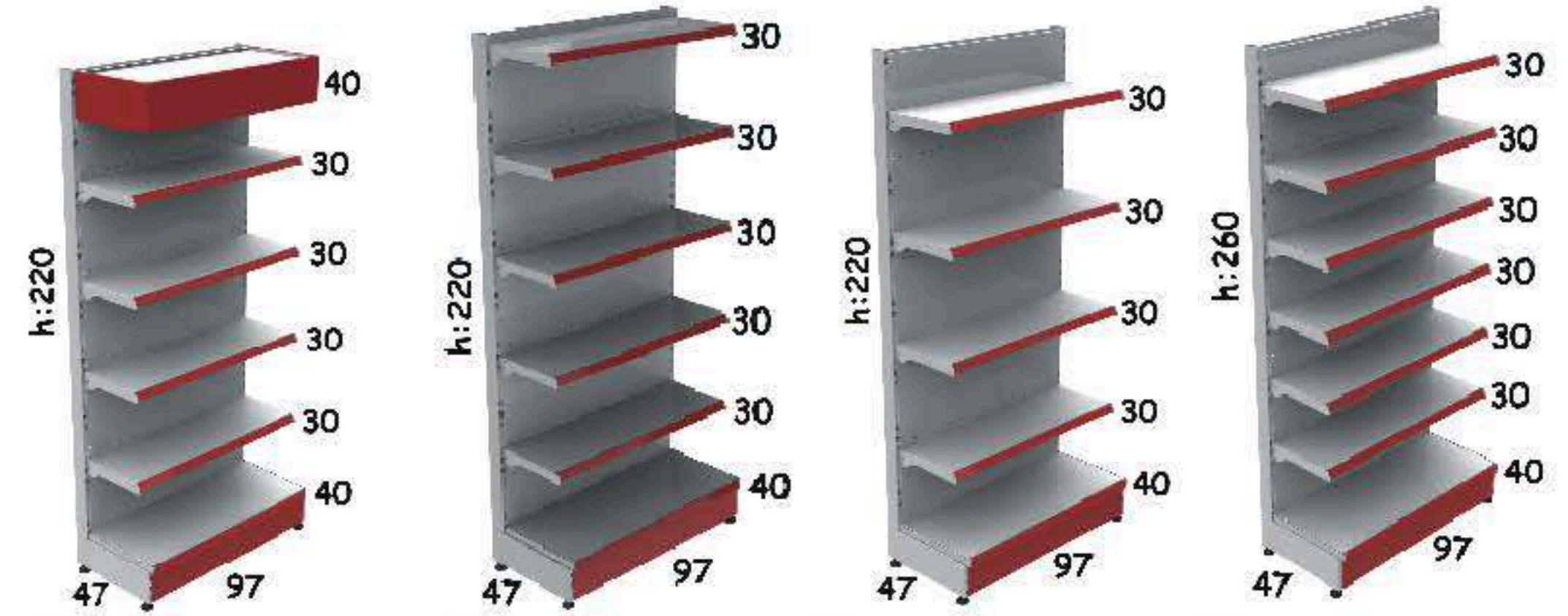

HR Eko Ünite

HR Eko Ünite

HR Eko Ünite

HR Eko Ünite

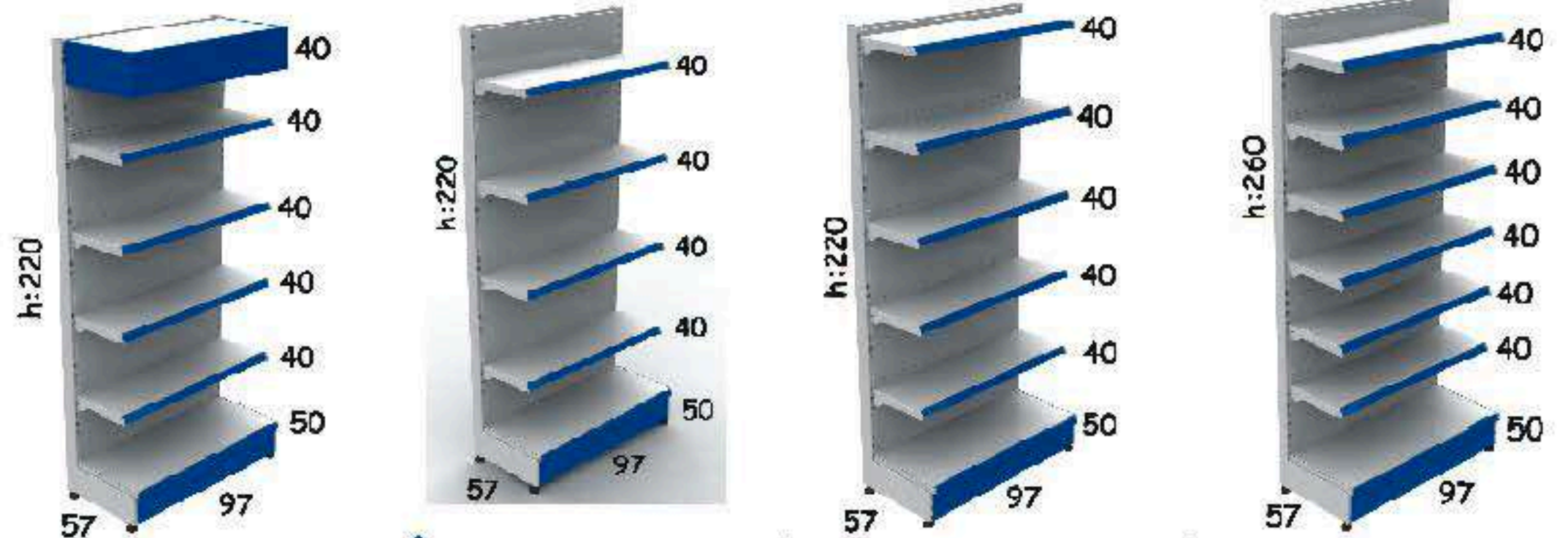

HR Standart Ünite

HR Standart Ünite

HR Standart Ünite

HR Standart Ünite

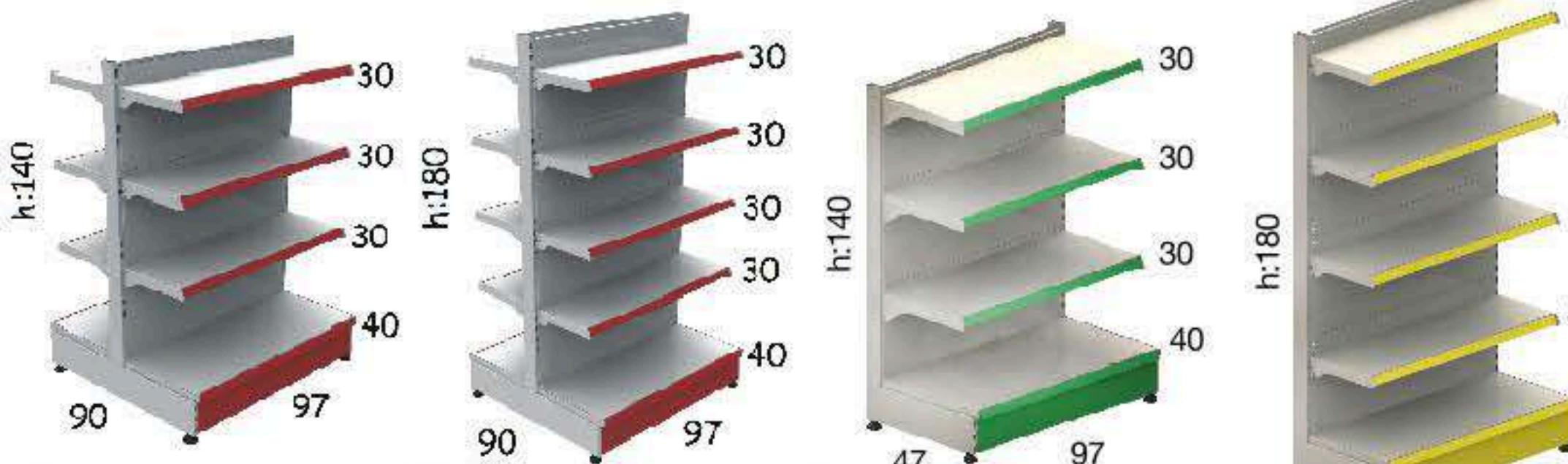

HR Eko Çiftli Orta Reyon

HR Eko Çiftli Orta Reyon

HR Eko Tekli Orta Reyon

HR Eko Tekli Orta Reyon



www.rafbak.com



www.rafgor.com



www.plastasya.com

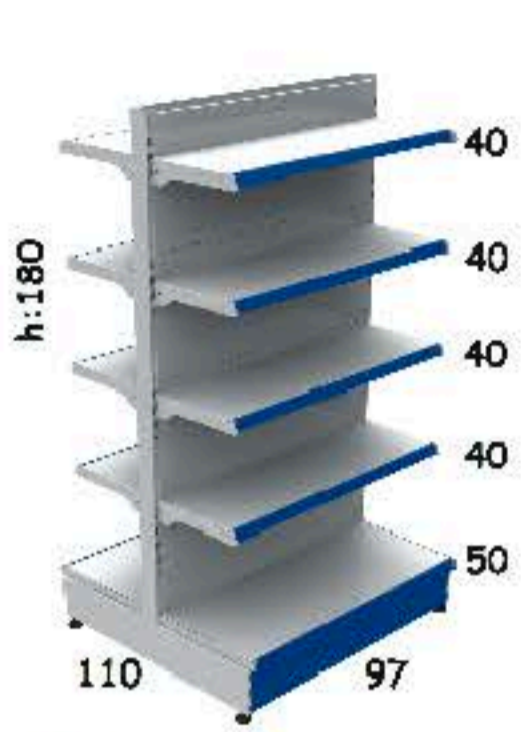

Standart Çiftli Orta Reyon

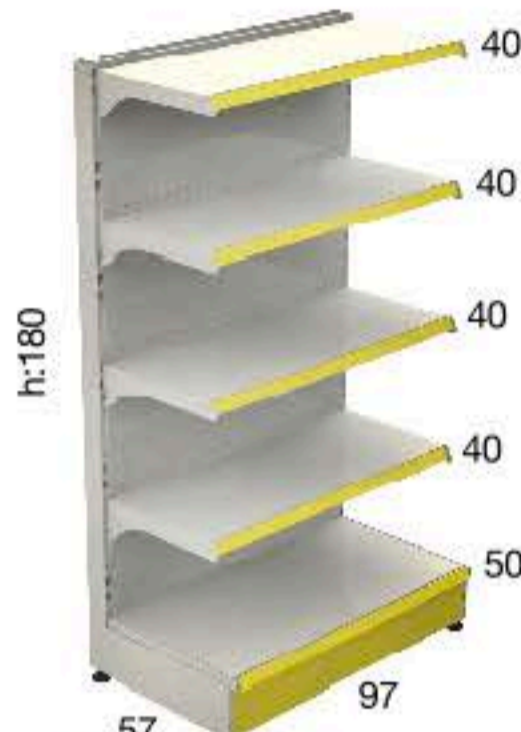

Standart Tekli Orta Reyon

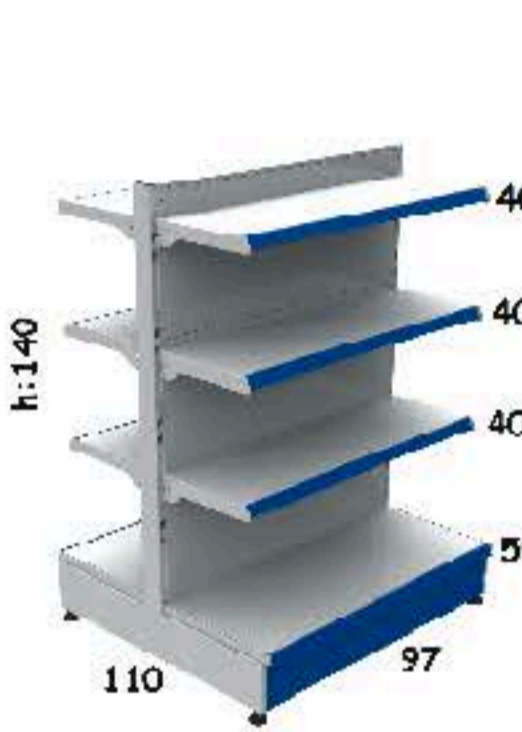

Standart Çiftli Orta Reyon

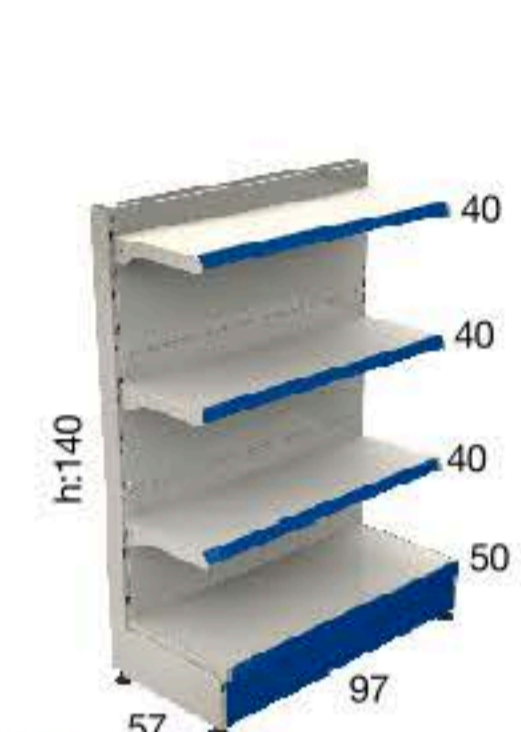

Standart Tekli Orta Reyon

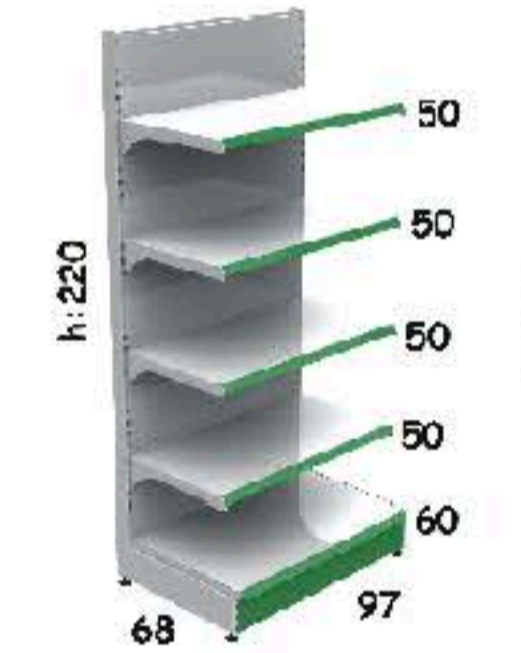

XL Duvar Ünitesi

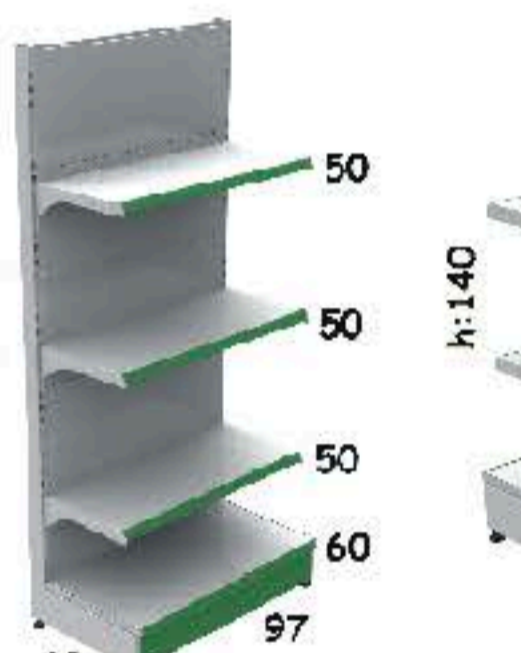

XL Duvar Ünitesi

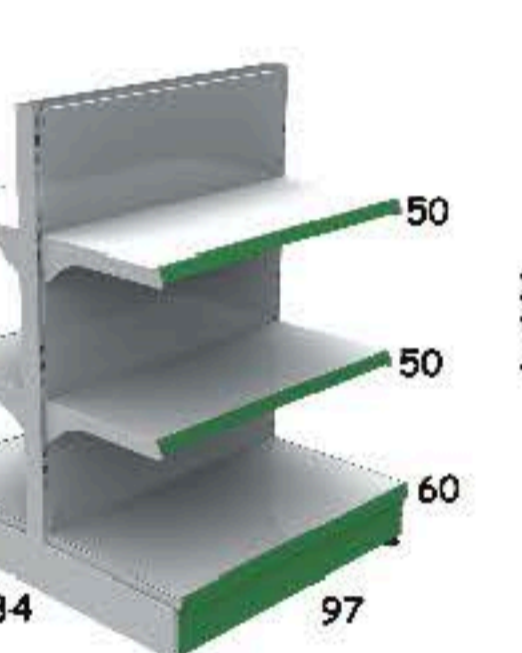

XL Çiftli Orta Reyon



XL Çiftli Orta Reyon

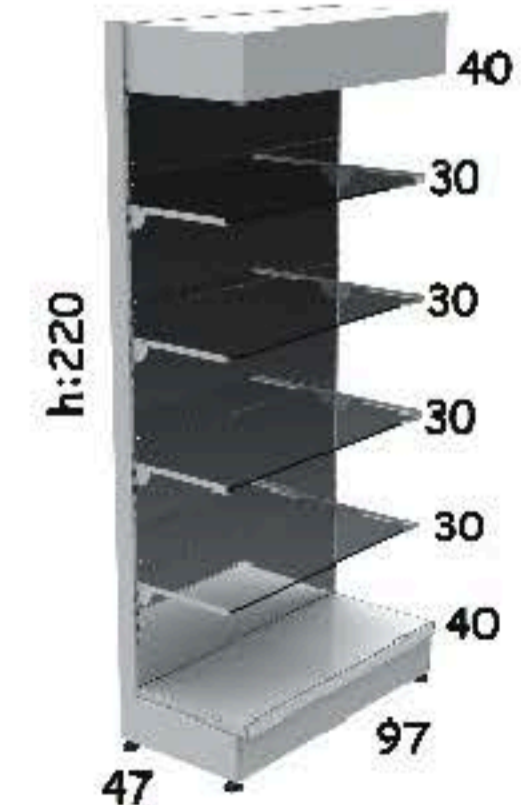

Kozmetik Ünitesi (Camlı-Aynalı)

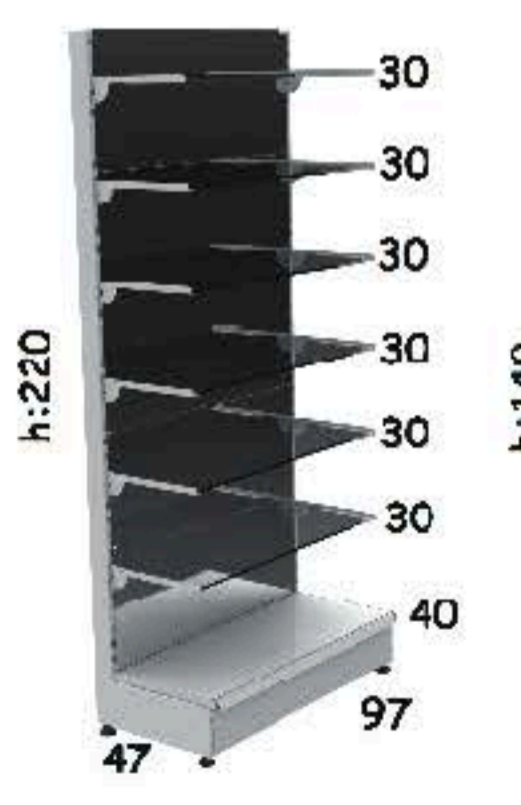

Kozmetik Ünitesi (Camlı-Aynalı)

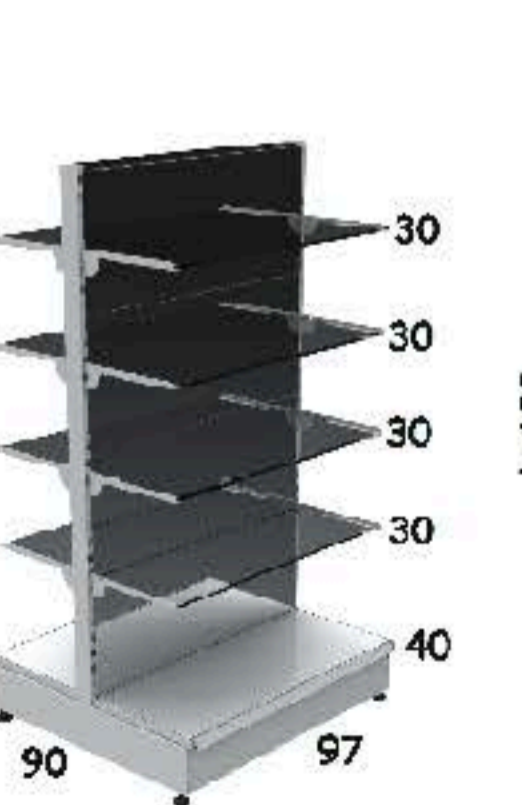

Kozmetik Çiftli Orta Reyon (Camlı-Aynalı)

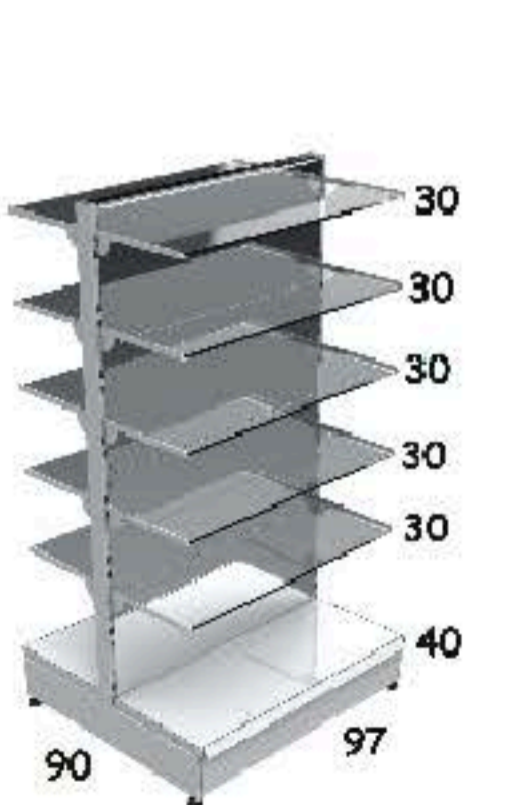

Kozmetik Çiftli Orta Reyon (Camlı-Aynalı)

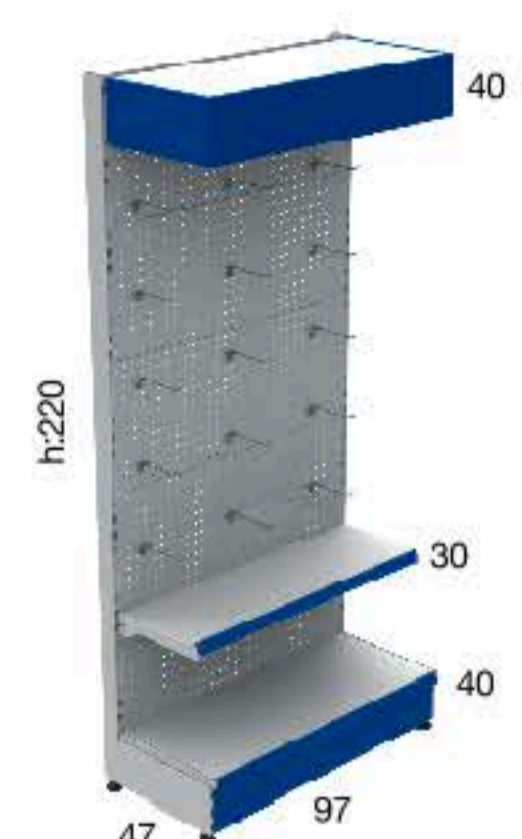

Eko Hirdavat Ünitesi

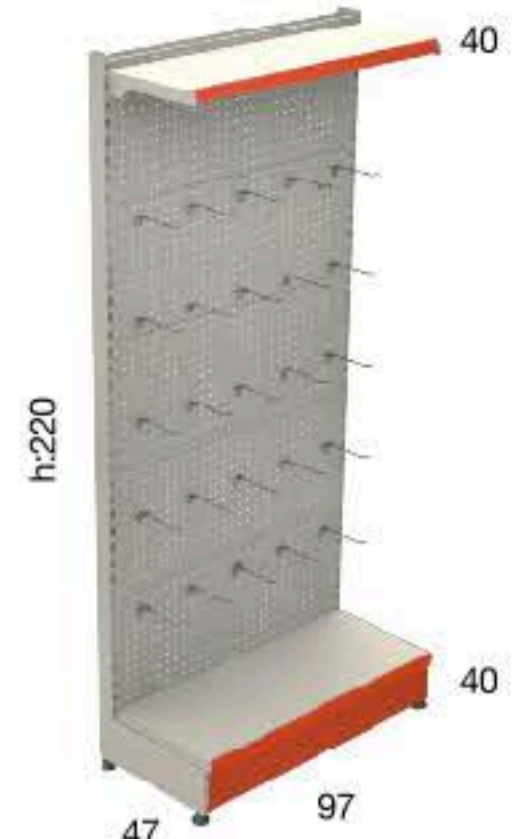

Eko Hirdavat Ünitesi

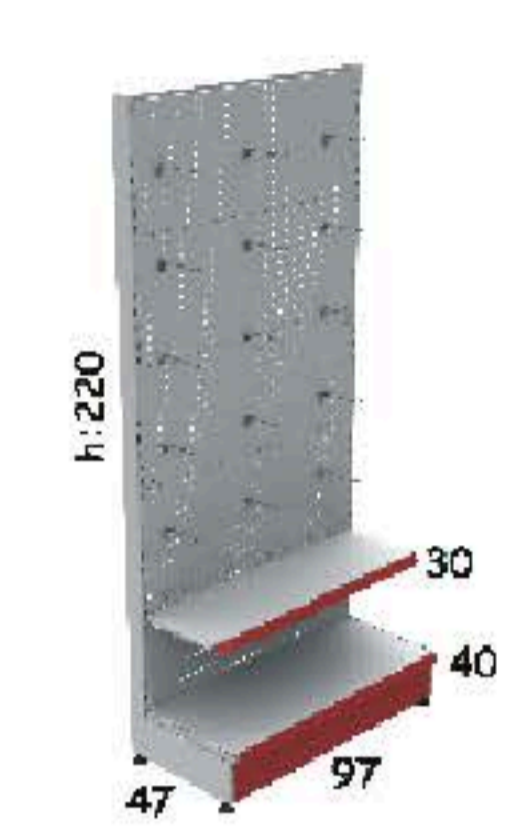

Eko Hirdavat Ünitesi

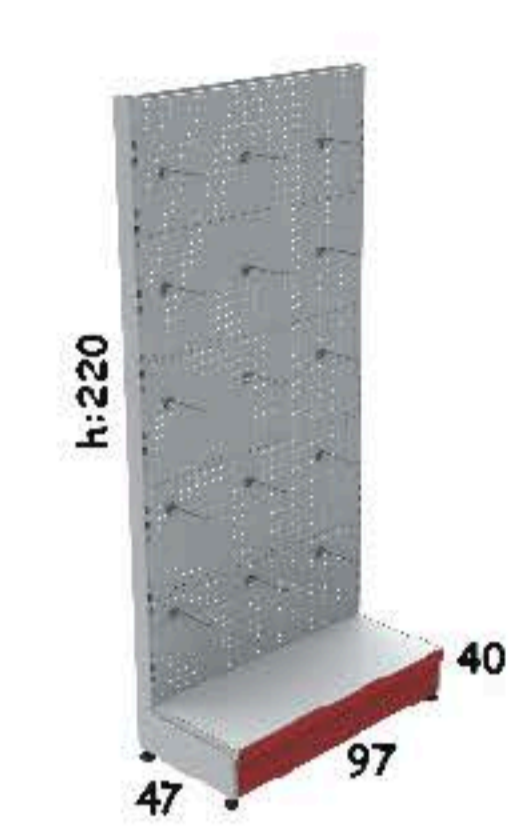

Eko Hirdavat Ünitesi



Kapı Ünitesi

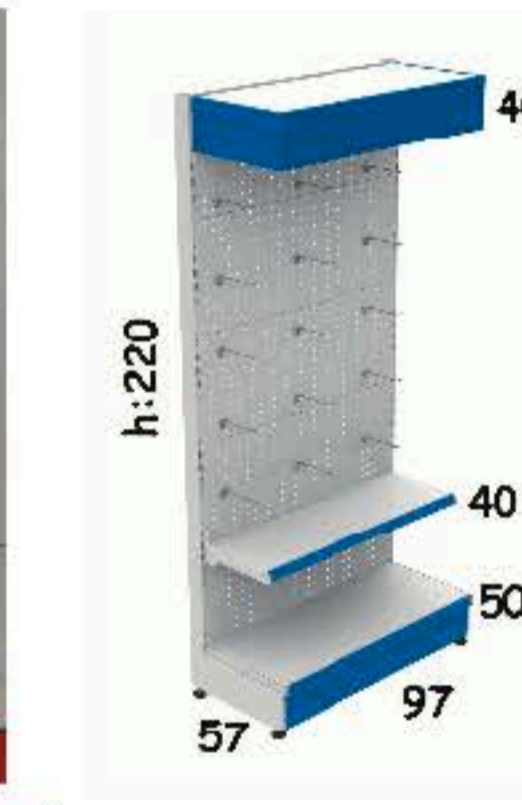

Standart Hirdavat Ünitesi

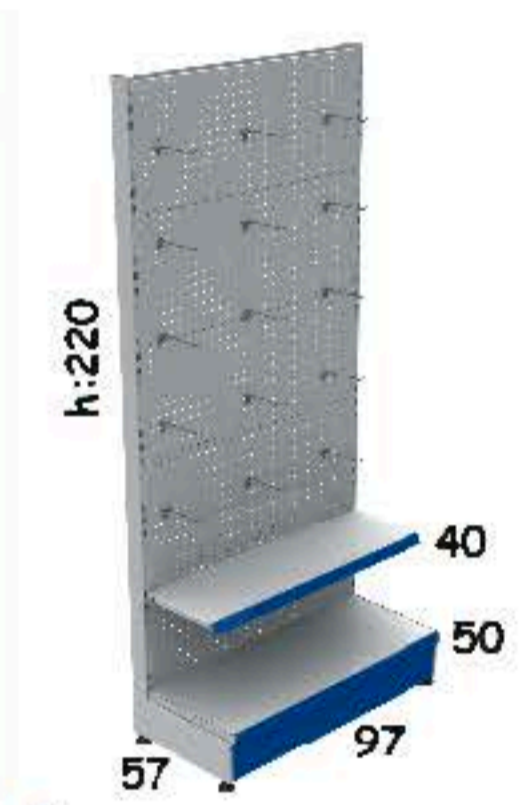

Standart Hirdavat Ünitesi

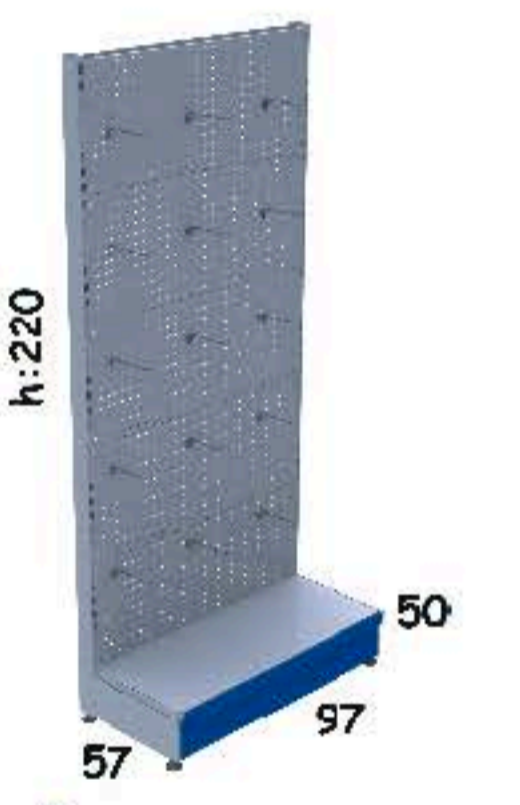

Standart Hirdavat Ünitesi

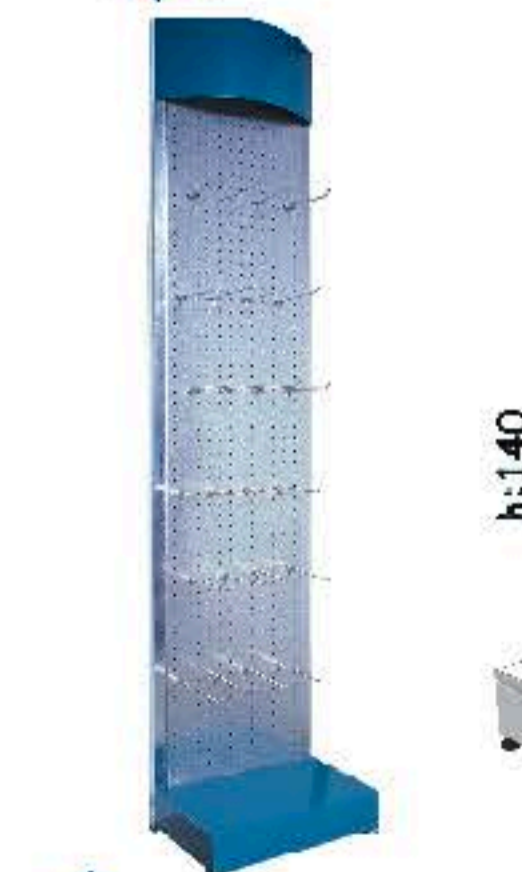

Hirdavat Ünitesi

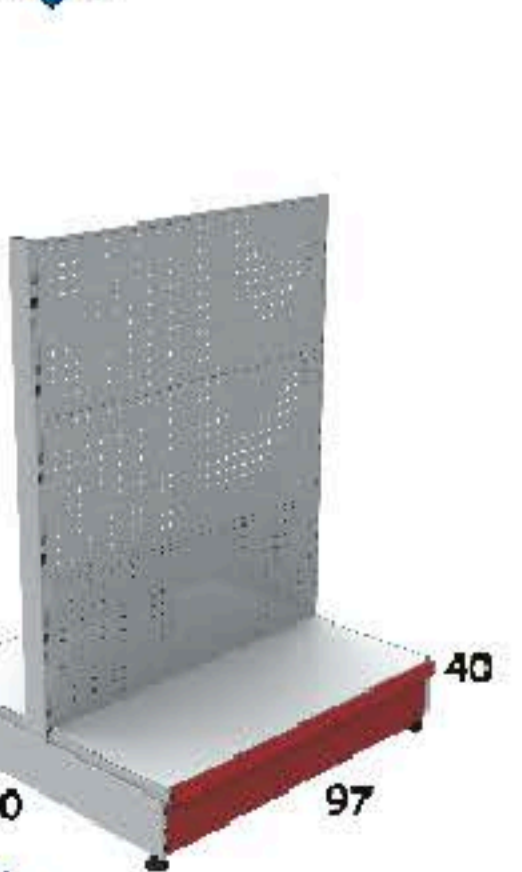

Eko Çiftli Delikli Orta Reyon

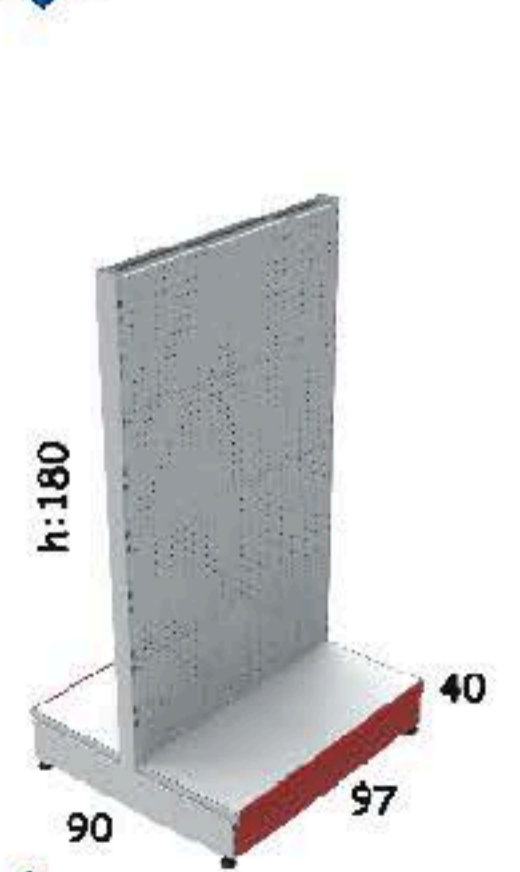

Eko Çiftli Delikli Orta Reyon

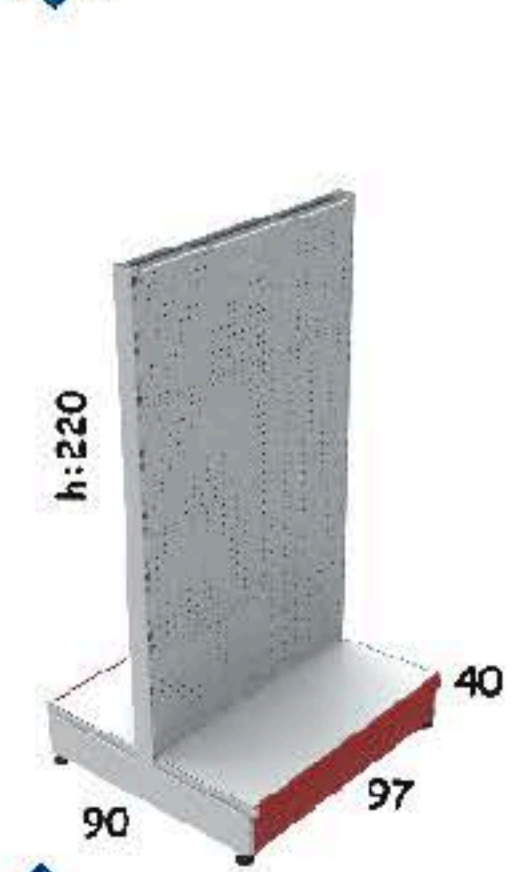

Eko Çiftli Delikli Orta Reyon



**HR** Duvar Reyonu



**HR** Kolon Üniteleri



**HR** Orta Reyon



**HR** Metal El Sepeti



**HR** Plastik El Sepeti



**HR** Servis Arabası



**HR** Bakliyat Kovası



**HR** Korkuluk



**HR** Suntalam Orta Reyon

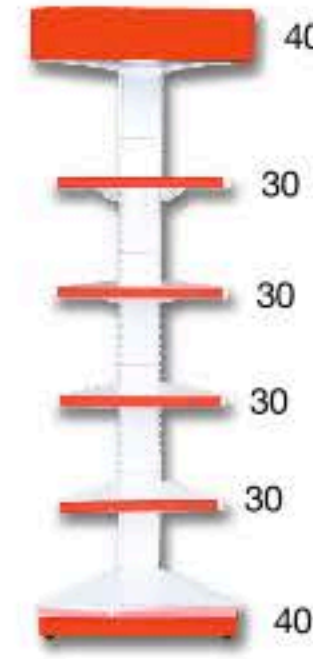
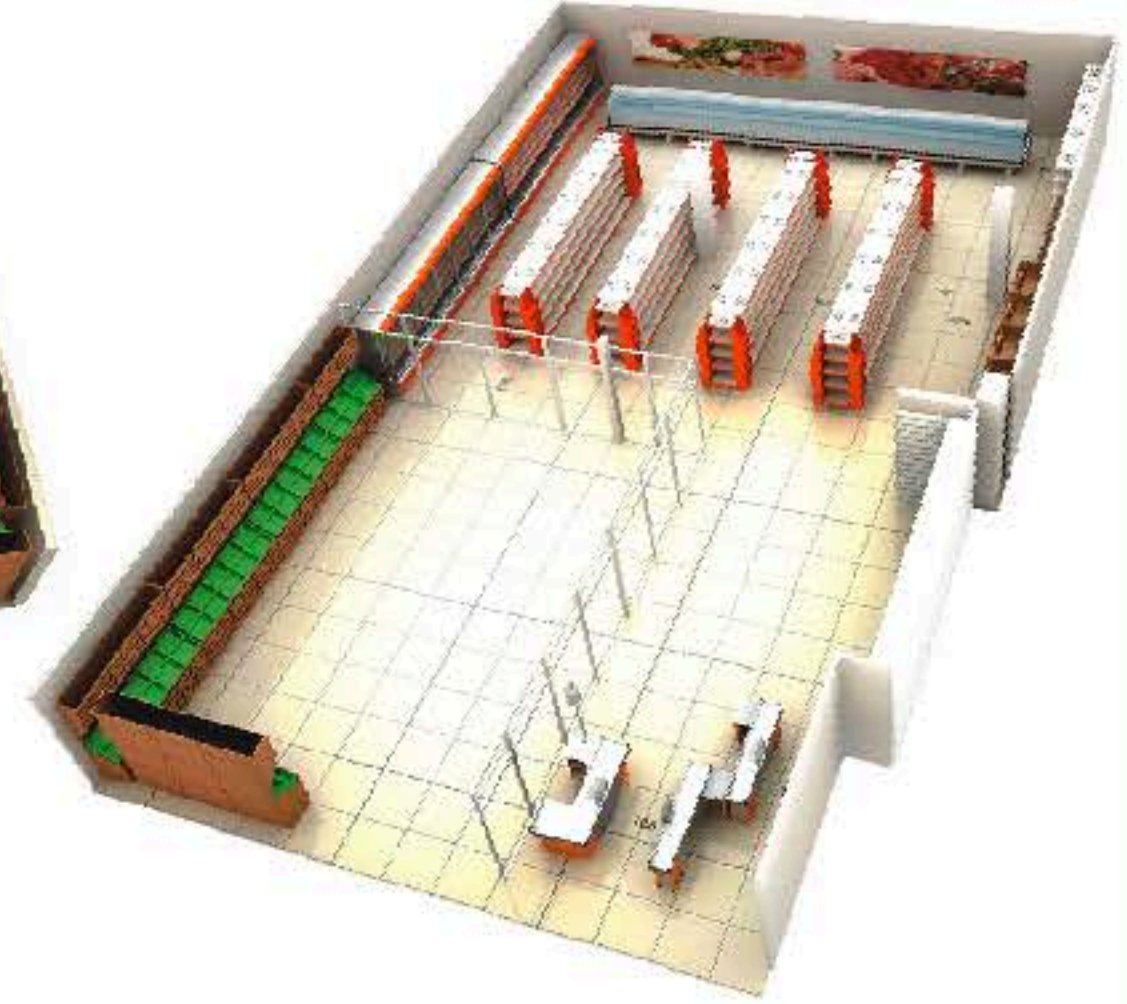
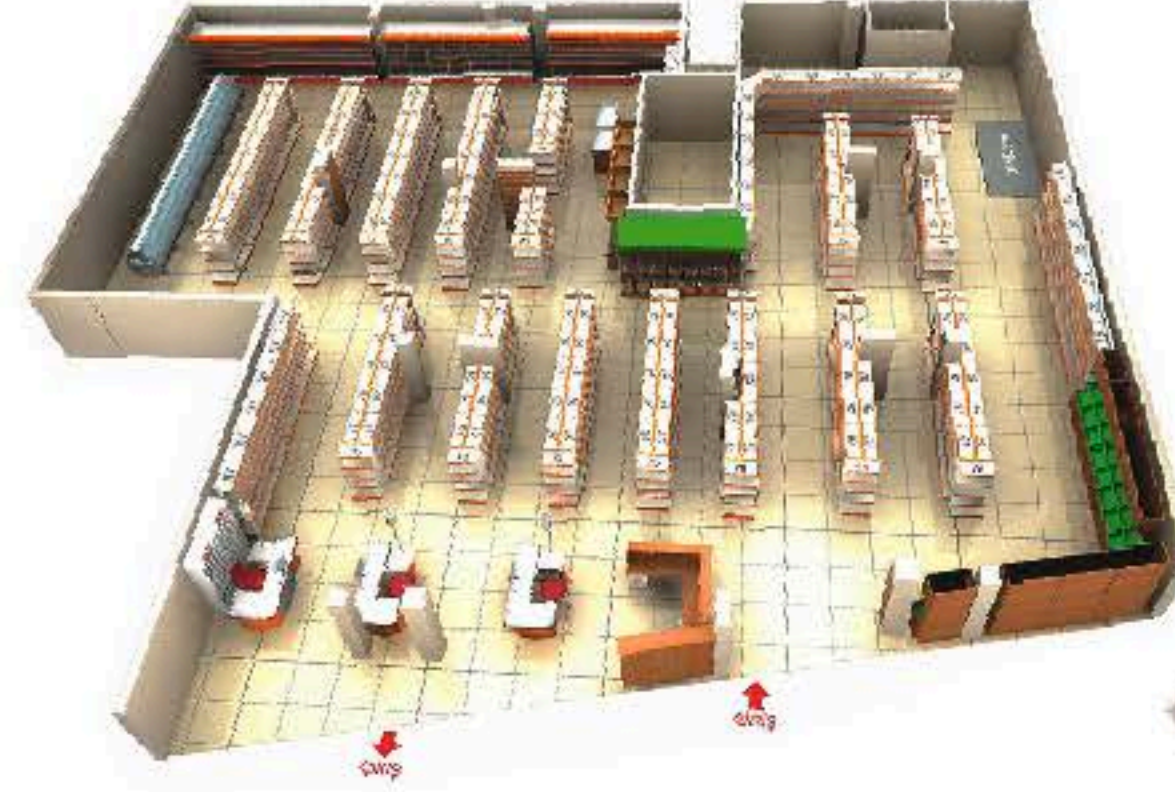

**HR** Dış Köşe Alınlı Duvar Ünitesi

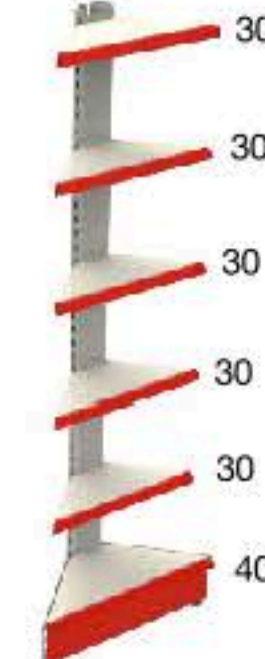

**HR** Dış Köşe Alınsız Duvar Ünitesi

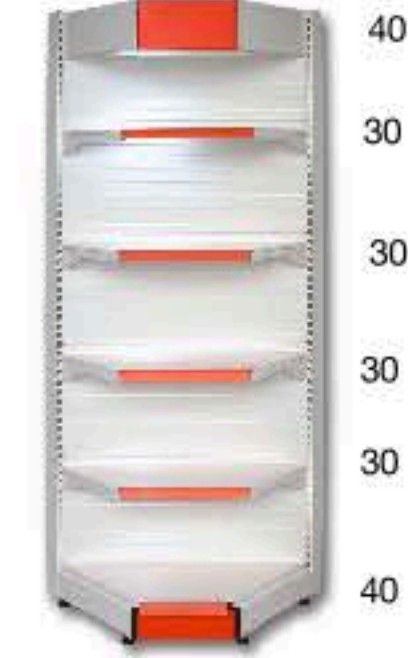

**HR** İç Köşe Alınlı Duvar Ünitesi

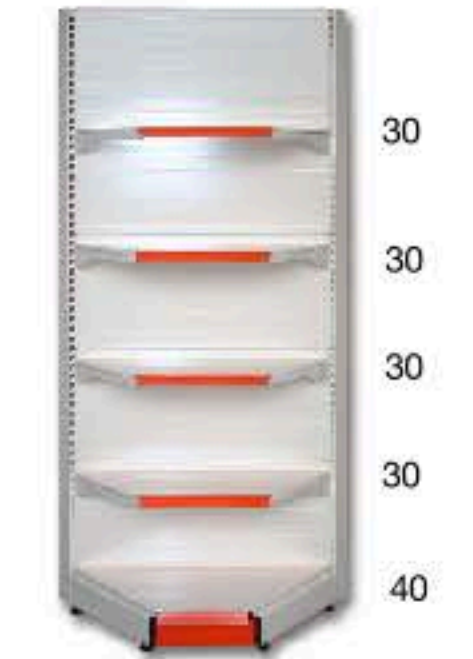

**HR** İç Köşe Alınsız Duvar Ünitesi



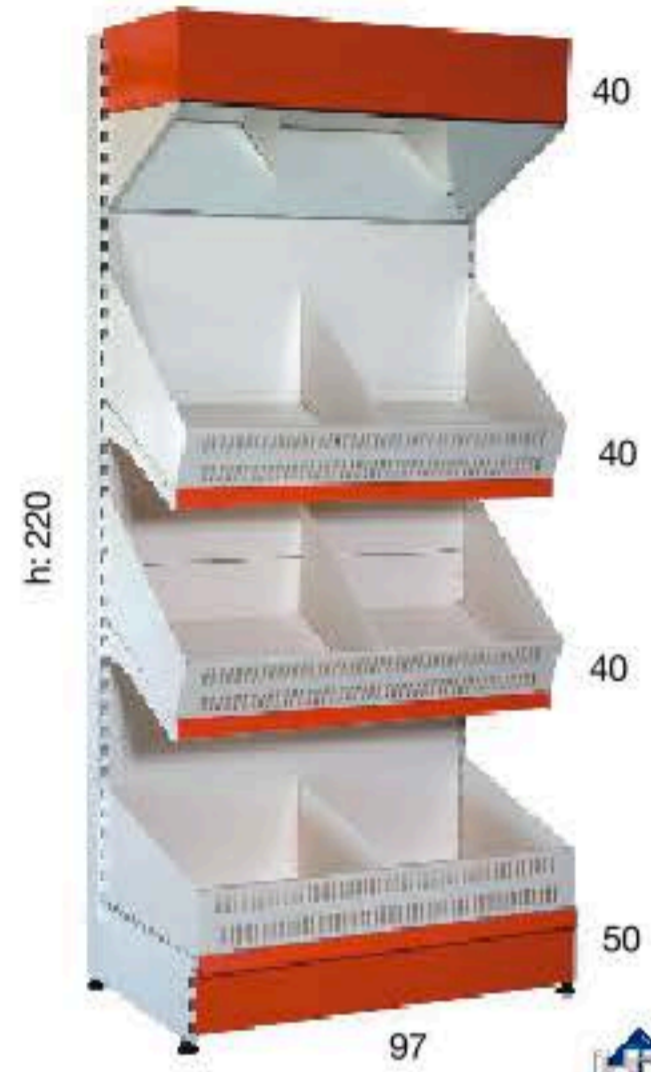

Manav Reyonu

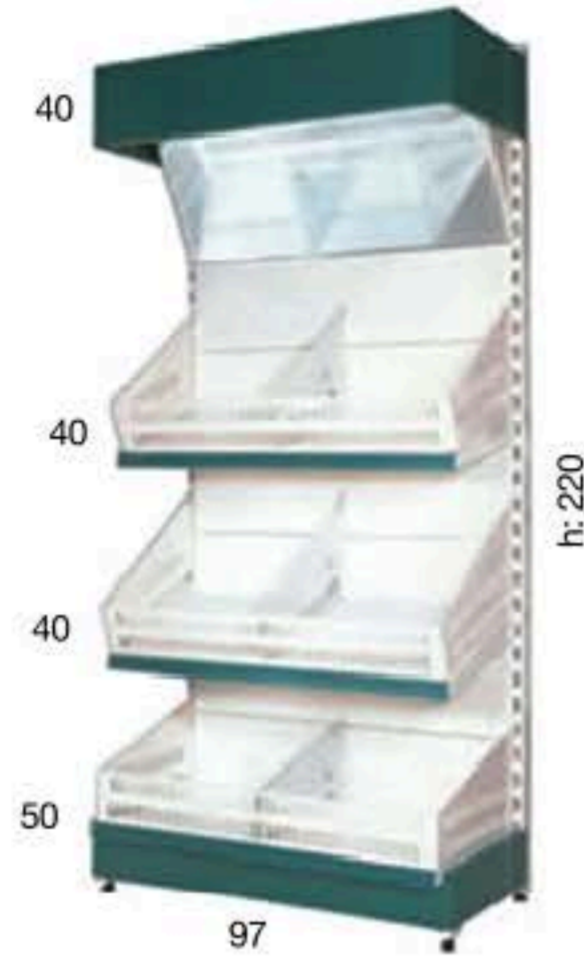

h: 220



Unlu Mamül Ünitesi



Ahşap Ekmek Dolabı



Ahşap Ekmek Dolabı



Unlu Mamül Ünitesi



Metal Ekmek Dolabı



Unlu Mamüller Ünitesi



Unlu Mamüller Ünitesi



Unlu Mamüller Ünitesi



Unlu Mamüller Uygulama



AŞŞAP MANAV REYONU



HR Eko L Kasa Altı



HR Lüks L Kasa Altı



HR Lüks U Kasa Altı



HR Eko U Kasa Altı



Yaprak Turnike



HR Çiftli Yaprak Turnike



HR Döner Turnike



HR Tekerlekli Market Sepeti



HR Plastik Alışveriş Sepeti



HR Fotoselli Turnike



HR Metal Alışveriş Sepeti



HR Market Arabası



HR Promosyon Sepeti



Ayak montaj detayı



Ayak kesit



Papuc 120



Papuc 95

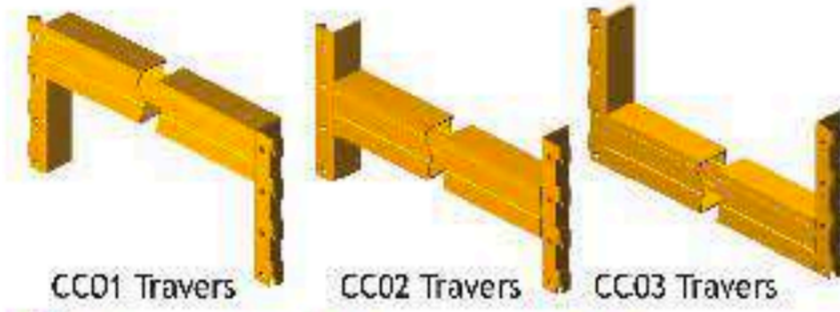

CC01 Travers CC02 Travers CC03 Travers



NPI01 Travers NPI02 Travers NPI03 Travers



Metal raf



Ahşap raf

Ağır Rack NPI Traves Tasıma Kapasiteleri		Heavy Duty Rack NPI Travers Permissible Load Capacities		Tasıma Kapasitesi Permissible Load Per Bay				
Profil	Yükseklik	En	Kalınlık	1800	2200	2700	3300	3500
Profile	Height	Width	Thickness					
NPI 80	80 mm	46 mm	-	2770	2350	1950	1550	
NPI 100	100 mm	55 mm	-	4500	3950	3250	2800	2600
NPI 120	120 mm	64 mm	-	4500	4500	4500	4000	3600



Ağır Rack NPI Travers



Ağır Rack CC Travers



Ağır Rack Kutu Traves Tasıma Kapasiteleri		Heavy Duty Rack Square Travers Permissible Load Capacities		Tasıma Kapasitesi Permissible Load Per Bay				
Profil	Yükseklik	En	Kalınlık	1800	2200	2700	3300	3500
Profile	Height	Width	Thickness					
50x100	100 mm	50 mm	2 mm	3000	2600	1950	1800	1400
50x100	100 mm	50 mm	2.5 mm	3300	2800	3250	2200	1800



Ağır Rack Kutu Travers



B	H	Profil
105	200	95x2.5 mm
105	250	95x2.5 mm
105	300	95x2.5 mm
105	350	95x2.5 mm
105	400	95x2.5 mm
105	450	95x2.5 mm
105	500	95x2.5 mm
105	550	95x2.5 mm
105	600	95x2.5 mm
105	650	95x2.5 mm
105	700	95x2.5 mm
105	750	95x2.5 mm
105	800	95x2.5 mm
105	850	95x2.5 mm
105	900	95x2.5 mm
105	950	95x2.5 mm
105	100	95x2.5 mm

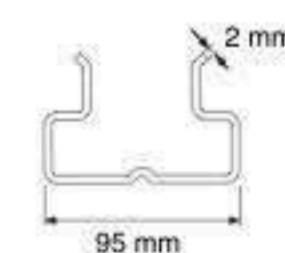
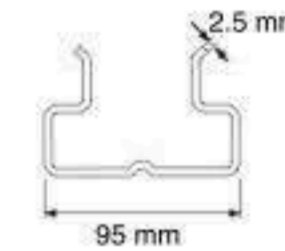

B	H	Profil
105	200	95x2.5 mm
105	250	95x2.5 mm
105	300	95x2.5 mm
105	350	95x2.5 mm
105	400	95x2.5 mm
105	450	95x2.5 mm
105	500	95x2.5 mm
105	550	95x2.5 mm
105	600	95x2.5 mm
105	650	95x2.5 mm
105	700	95x2.5 mm
105	750	95x2.5 mm
105	800	95x2.5 mm
105	850	95x2.5 mm
105	900	95x2.5 mm
105	950	95x2.5 mm
105	100	95x2.5 mm

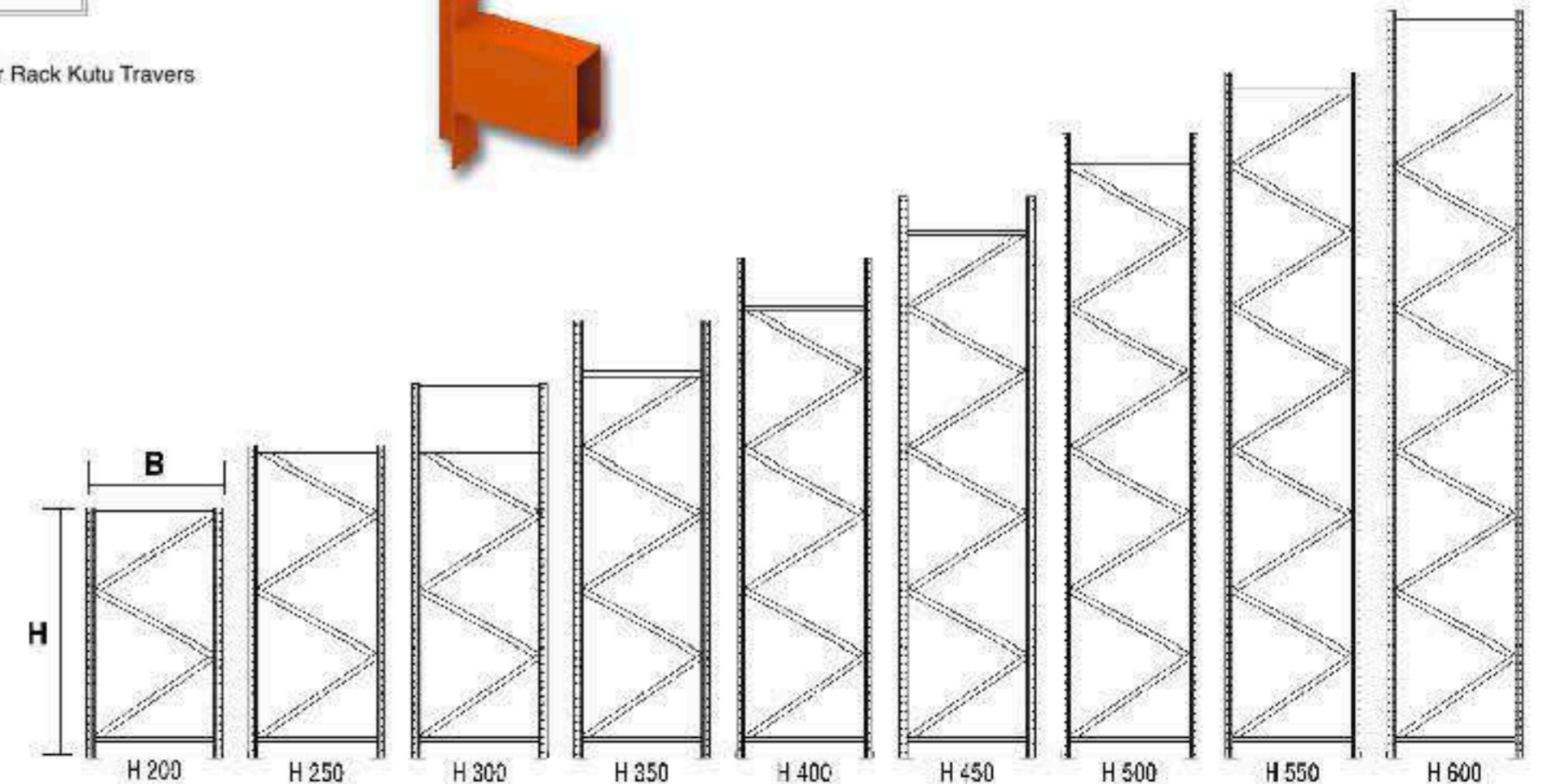

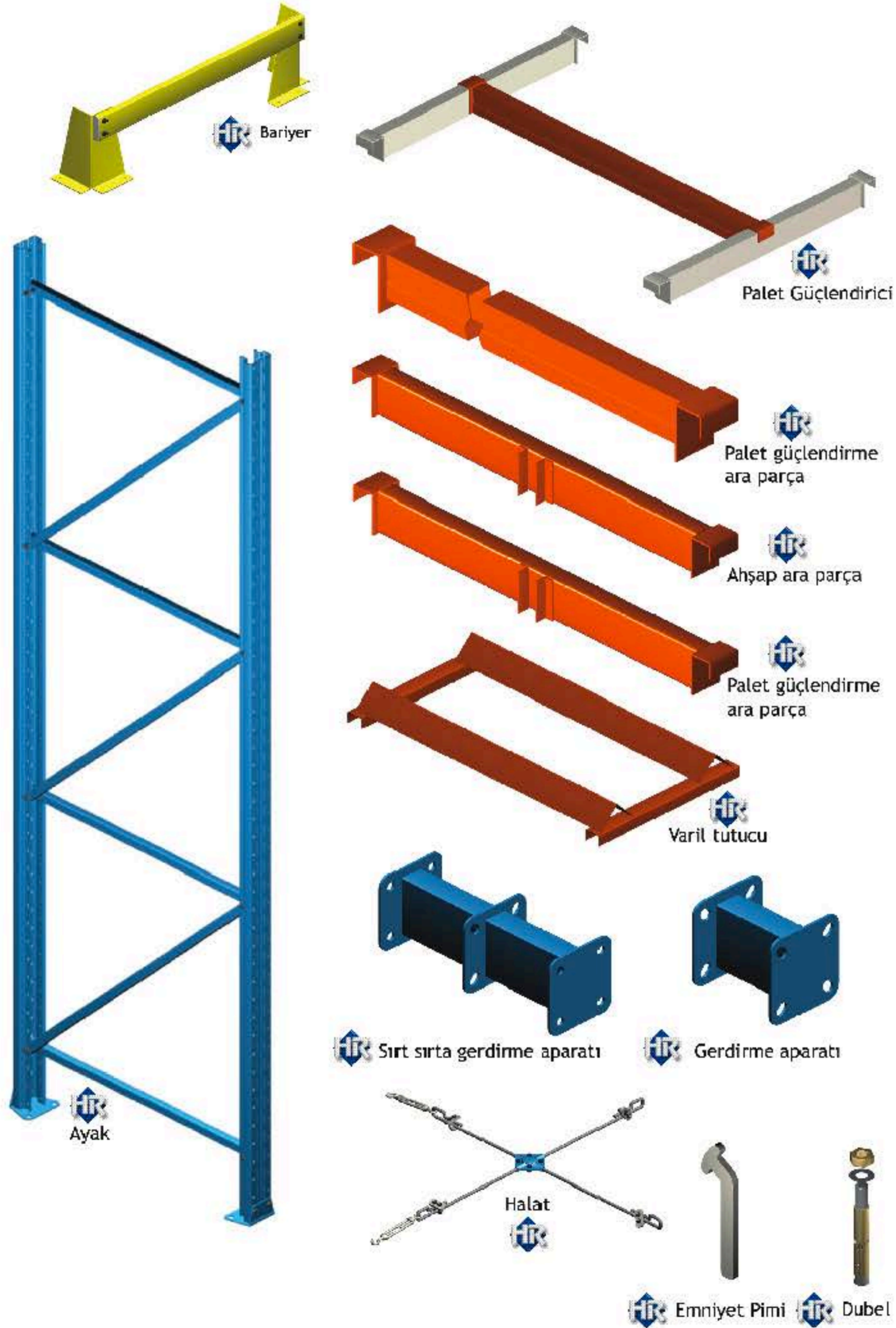





**HR** Ağır Rack Uygulama

**HR** Ağır Rack Uygulama

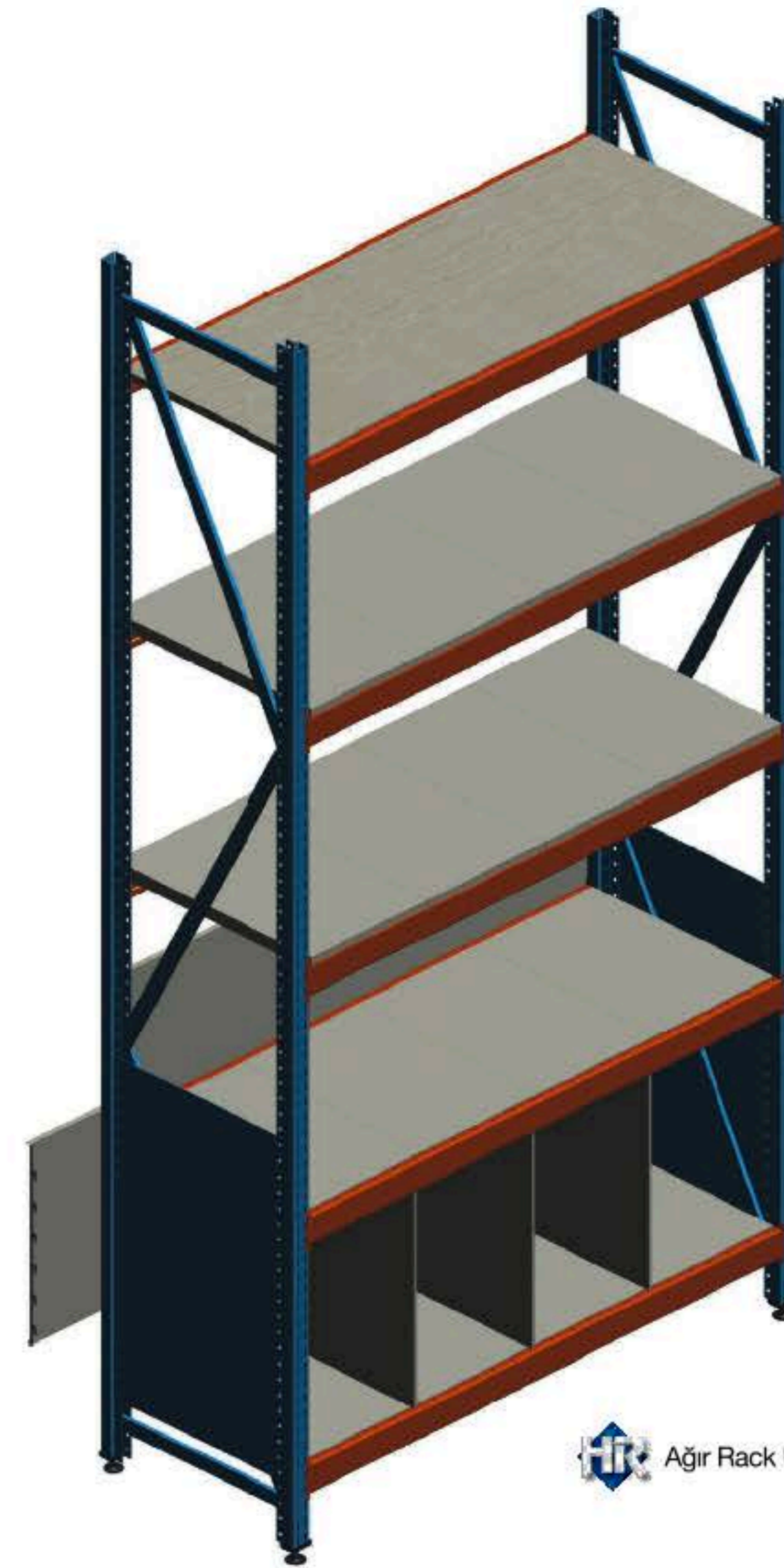

**HR** Ağır Rack Uygulama

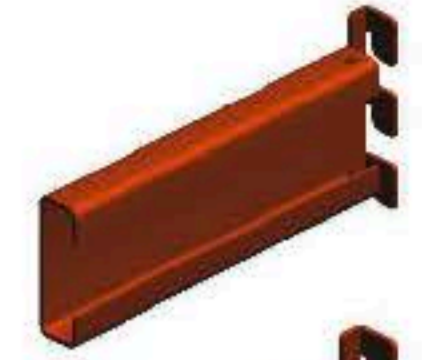

**HR**  
A tipi travers

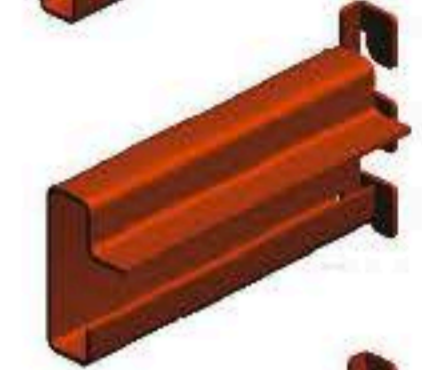

**HR**  
B tipi travers

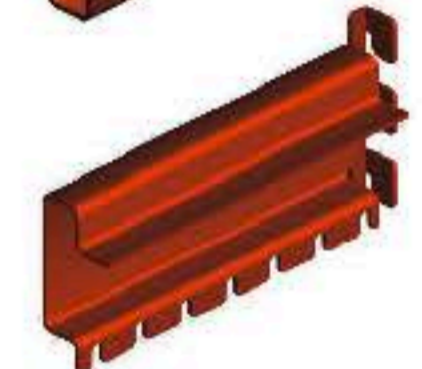

**HR**  
Separatör  
Traversi ek



**HR**  
Hafif rack kesit



**HR** Ayak Pabucu



**HR** Yere Bağlantı Aparatı



**HR** Metal tabla gösterimi  
A tipi

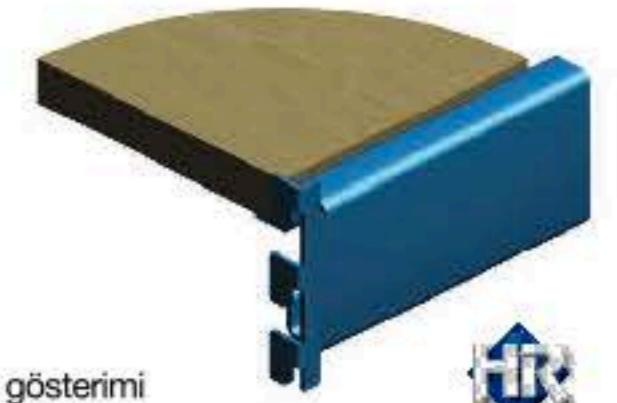

**HR**  
Ahşap tabla görünümü  
B tipi

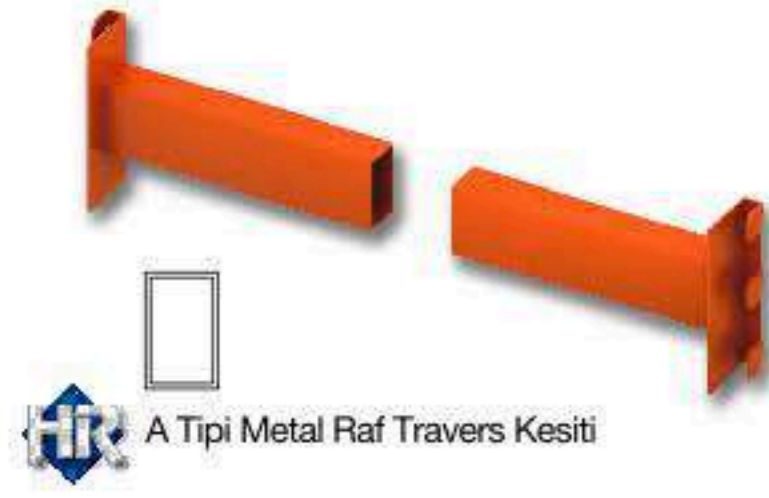

A Tipi / Hafif Rack Travers Tasıma Kapasiteleri		Type A / Light Duty Rack Travers Permissible Load Capacities		Tasıma Kapasitesi			
A Tipi		Type A		Permissible Load Per Bay			
Profil	Yükseklik	En	Kalınlık	900	1200	1500	1800
Profile	Height	Width	Thickness	900	1200	1500	1800
30x50	50 mm	30 mm	1.5 mm	280	240	200	160
30x50	50 mm	30 mm	2 mm	335	290	245	200
40x60	60 mm	40 mm	1.5 mm	350	300	250	200
40x60	60 mm	40 mm	2 mm	400	350	300	250

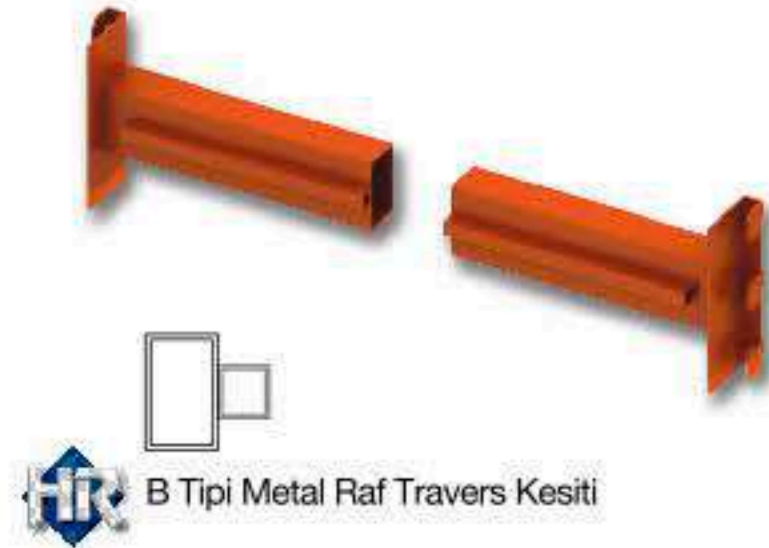

B Tipi / Hafif Rack Travers Tasıma Kapasiteleri		Type B / Light Duty Rack Travers Permissible Load Capacities		Tasıma Kapasitesi			
B Tipi		Type B		Permissible Load Per Bay			
Profil	Yükseklik	En	Kalınlık	900	1200	1500	1800
Profile	Height	Width	Thickness	900	1200	1500	1800
30x50	50 mm	30 mm	1.5 mm	300	260	220	180
30x50	50 mm	30 mm	2 mm	335	310	265	220
40x60	60 mm	40 mm	1.5 mm	370	320	270	220
40x60	60 mm	40 mm	2 mm	420	370	320	270

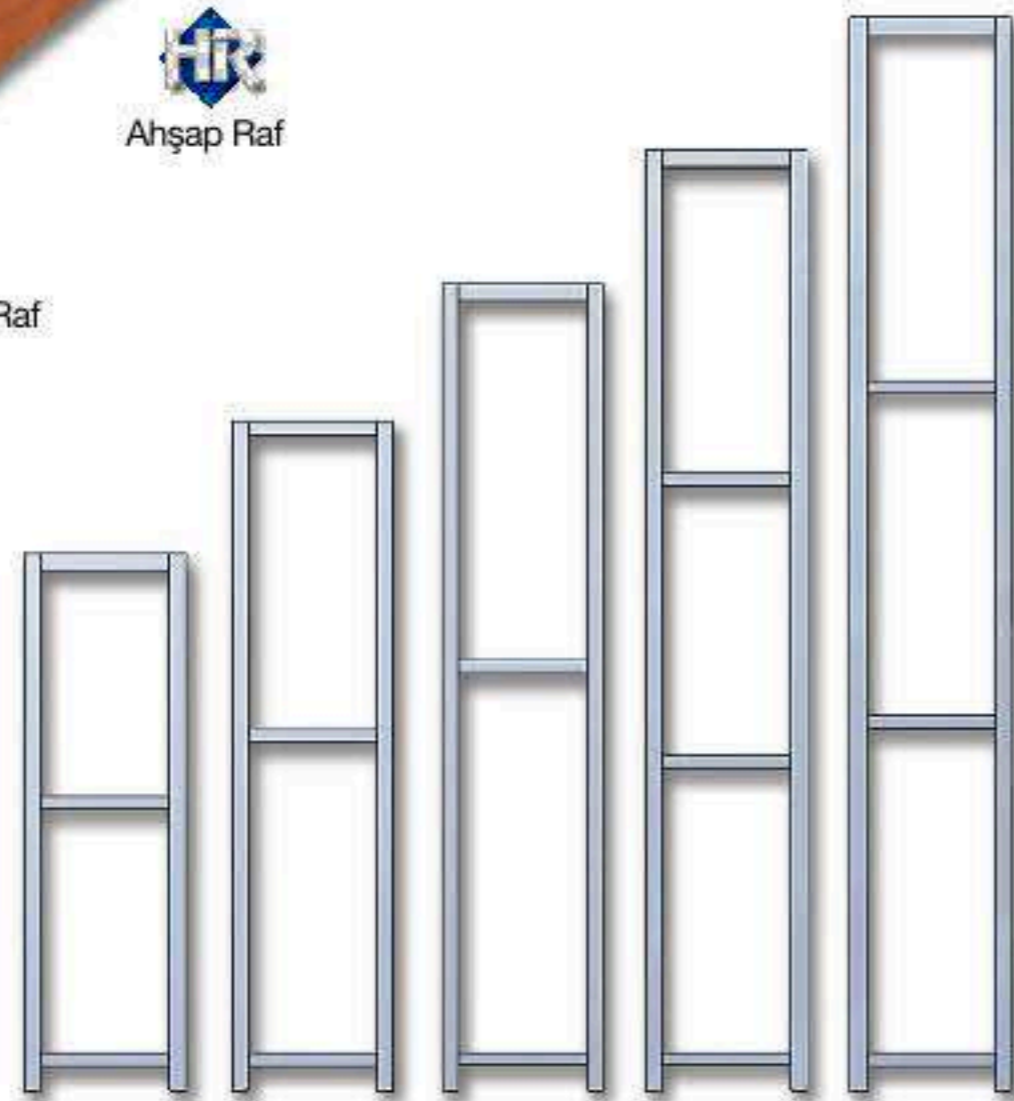

Hafif Rack Ayak Ölçüleri		Light Duty Rack Upright Dimensions		Tasıma Kapasitesi								
B Tipi		Type B		Permissible Load Per Bay								
2000	2500	3000	3500	4000	40	50	60	70	80	90	30x50x1.5 mm	30x6x2 mm
2000	2500	3000	3500	4000	40	50	60	70	80	90	30x50x1.5 mm	30x6x2 mm
2500	3000	3500	4000		40	50	60	70	80	90	30x50x1.5 mm	30x6x2 mm
3000	3500	4000			40	50	60	70	80	90	30x50x1.5 mm	30x6x2 mm
3500	4000				40	50	60	70	80	90	30x50x1.5 mm	30x6x2 mm
4000					40	50	60	70	80	90	30x50x1.5 mm	30x6x2 mm

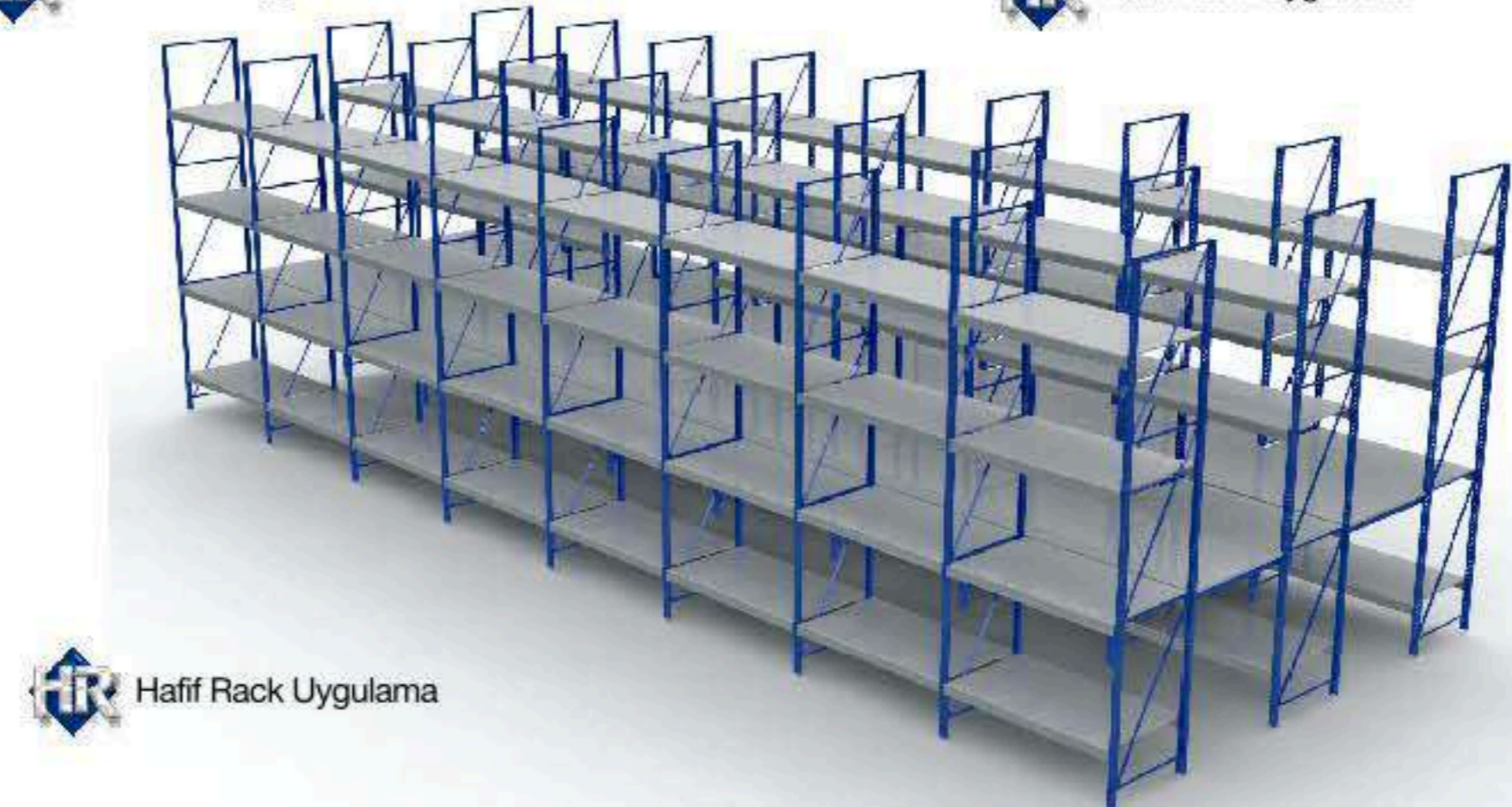
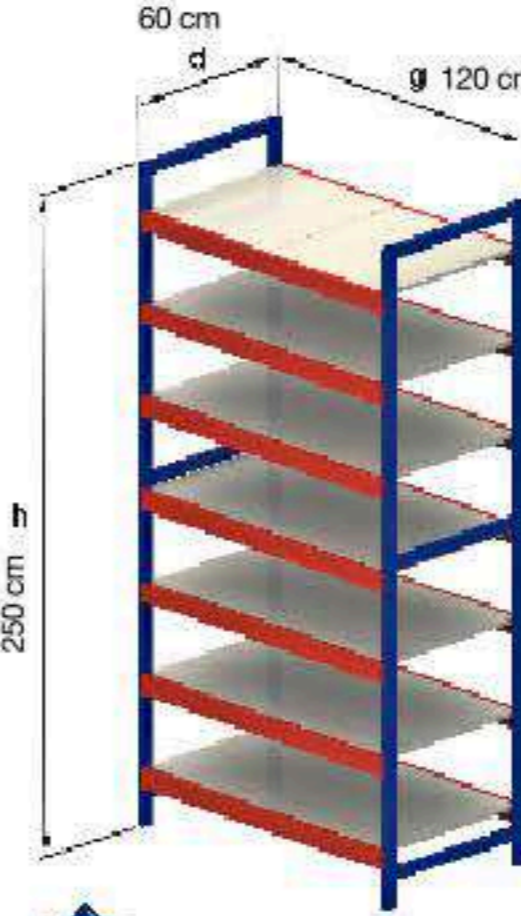
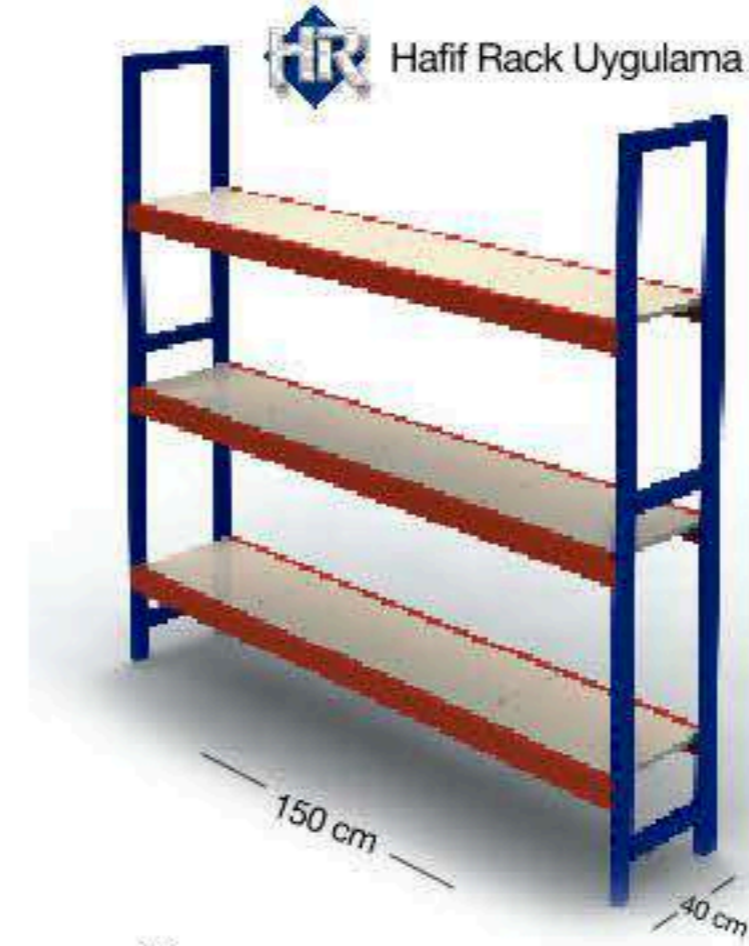

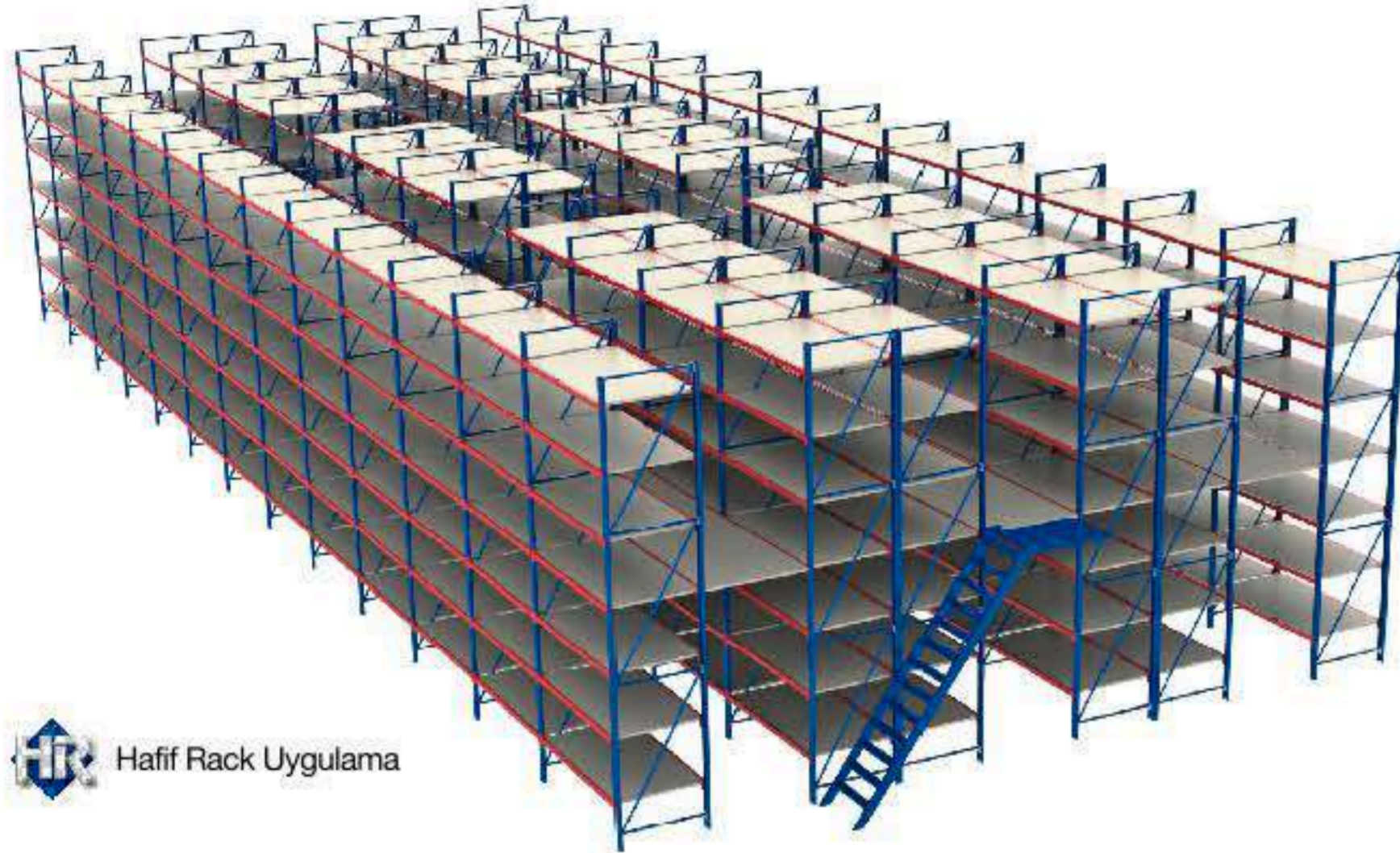

**HR** Hafif Rack Uygulama

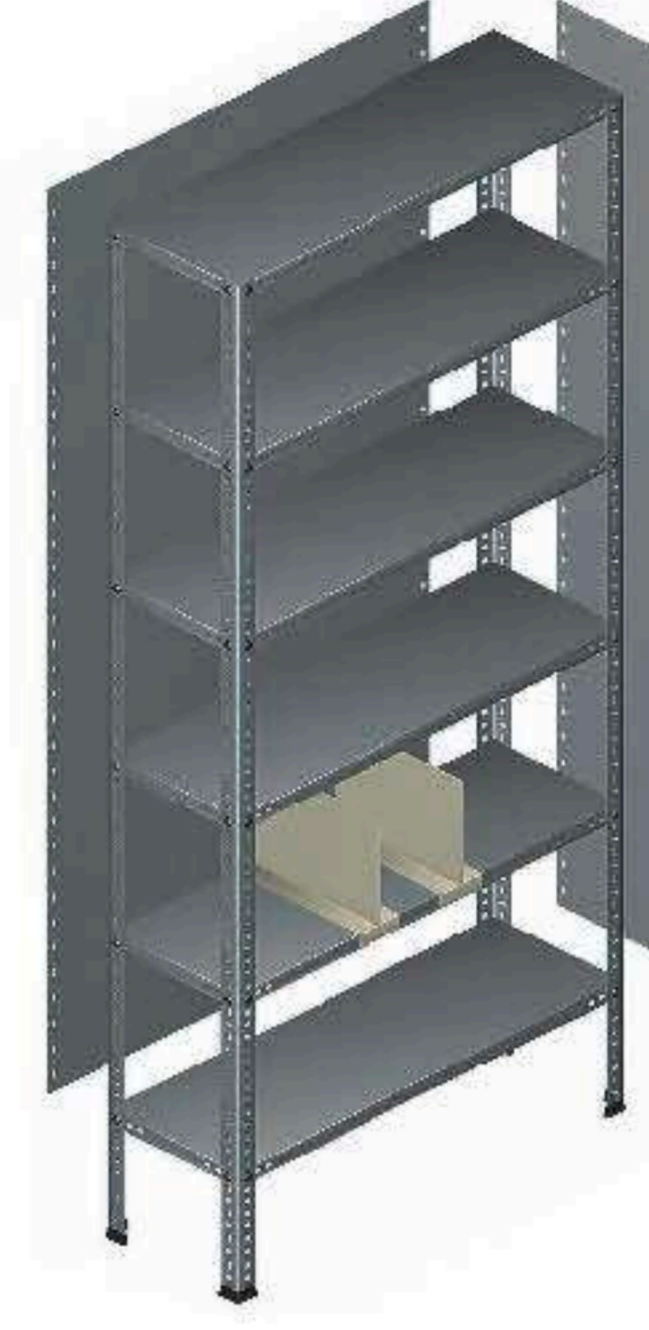
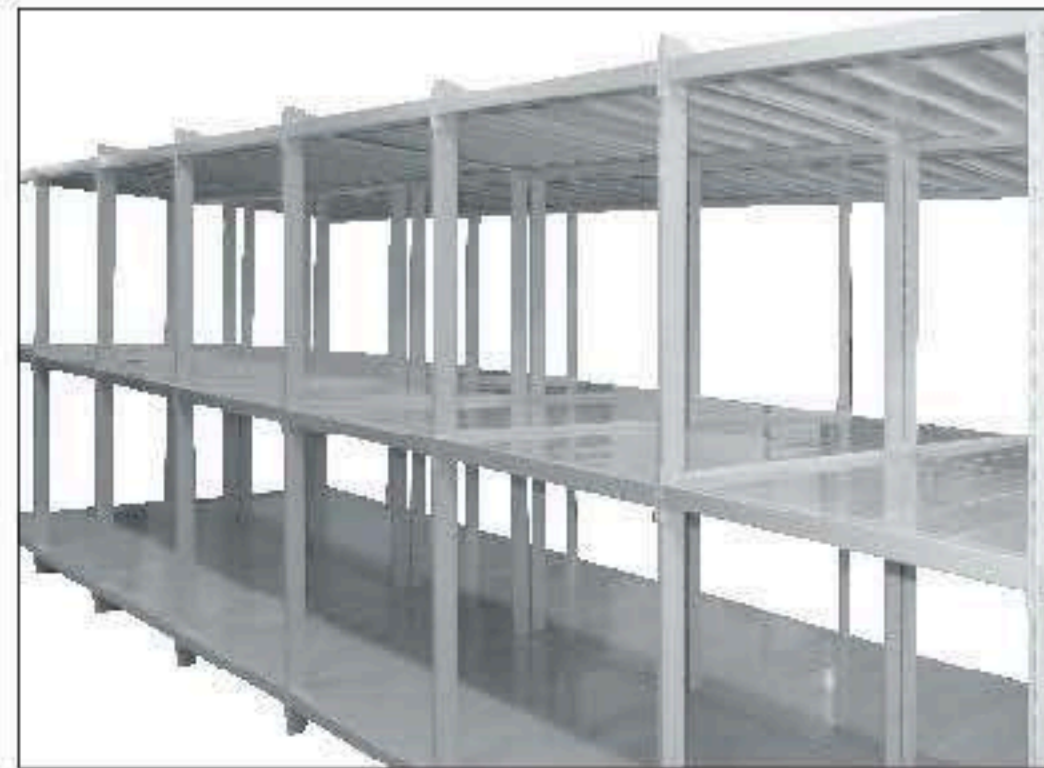

**HR** Çelik Raf

STEEL SHELF TYPE ÇELİK RAF TİPİ		PERMISSIBLE LOAD PER BAY TAŞIMA KAPASİTESİ (KG)
SIZE ÖLÇÜ	THICKNESS KALINLIK	KG.
31x93	0.7 mm	75
31x93	1 mm	105
31x93	1.2 mm	120
31x75	0.7 mm	65
31x59	0.7 mm	120
31x43	0.7 mm	120
43x93	0.7 mm	90
43x93	1 mm	120
43x93	1.2 mm	130
43x93	1.5 mm	160
43x75	0.7 mm	90
43x59	0.7 mm	125
43x43	0.7 mm	125
56x93	1 mm	100
56x93	1.2 mm	120
56x93	1.5 mm	200
56x93	2 mm	250
75x93	1.2 mm	200
75x93	1.5 mm	230
93x93	1.2 mm	230
93x93	1.5 mm	290
93x93	2 mm	300

UPRIGHT TYPE PROFİL TİPİ			PERMISSIBLE LOAD PER BAY TAŞIMA KAPASİTESİ (KG)
SIZE ÖLÇÜ	LENGTH L BOYU	THICKNESS KALINLIK	KG.
40x40	2000	1.5 mm	480
40x40	2000	2 mm	600
40x60	2000	1.5 mm	750
40x60	2000	2 mm	950

Mentioned weights are for secured distributed loads.  
Tabloda gösterilen ağırlık (kg) güvenli ağırlık dağılımı yüküne aittir.



**HR** Raf Tabla



**HR** Kesit



**HR** Plastik Taban



**HR** Civata



**HR** Lama

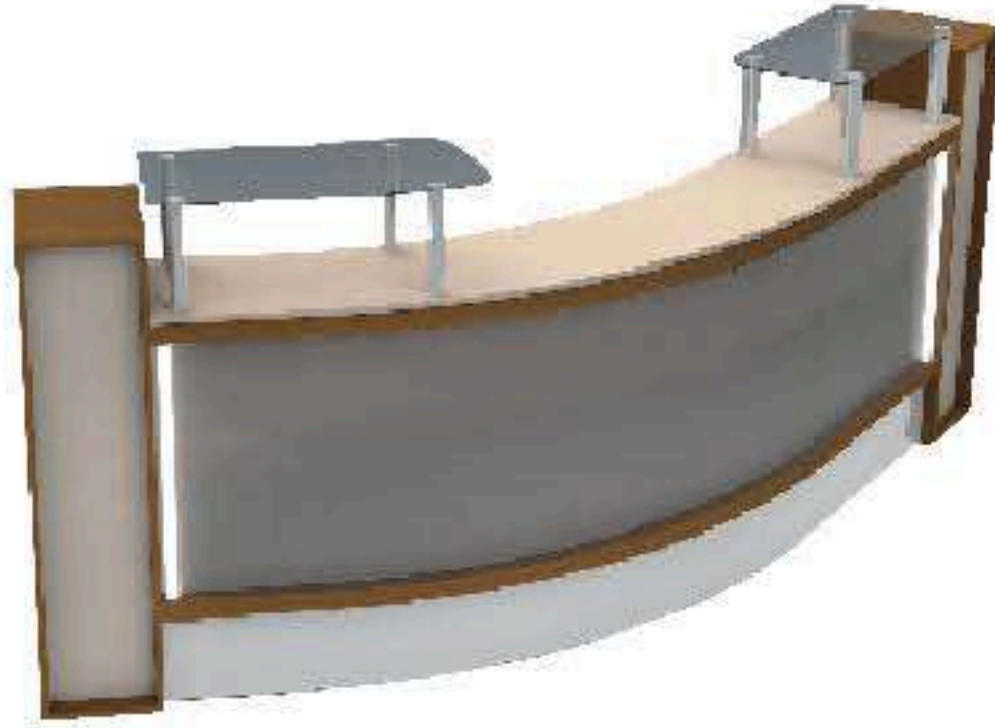

HR Lüks Danışma Bankosu 01



HR Lüks Danışma Bankosu 01

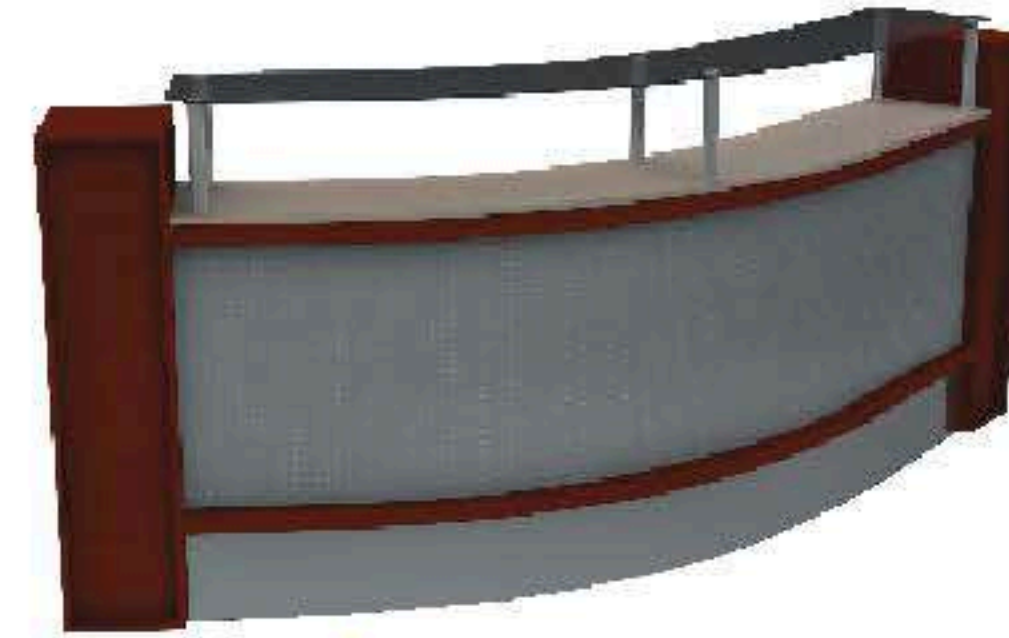

HR Lüks Danışma Bankosu 04



HR Lüks Kanyon Kasa Banko 5

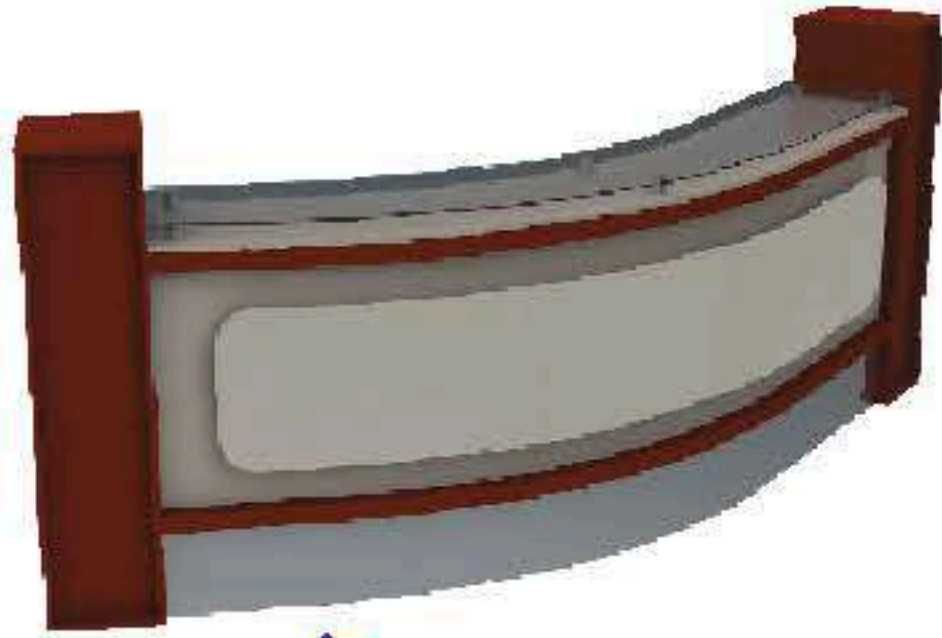

HR Lüks Danışma Bankosu 02



HR Lüks Danışma Bankosu 02

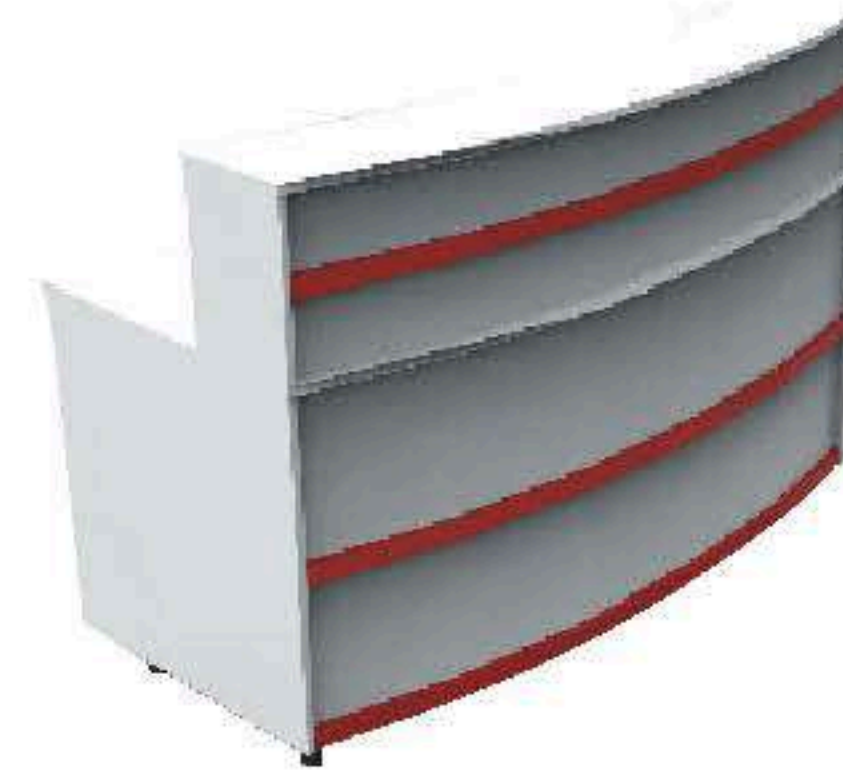

HR Lüks Danışma Bankosu 06



HR Lüks Danışma Bankosu 06



HR Piramit Stand



HR Lüks Danışma Bankosu 03



HR Lüks Danışma Bankosu 07





**HR** Lüks Çizgili Danışma Bankosu 09



**HR** Lüks Ay Camlı Danışma Bankosu 10



**HR** Lüks Sembol Danışma Bankosu 11



**HR** Lüks Sembol Danışma Bankosu 11



**HR** Lüks Delta Servis Danışma Bankosu 12



**HR** Lüks Delta Servis Danışma Bankosu 12



**HR** Lüks Danışma Bankosu 13



**HR** Lüks U Danışma Bankosu 14



**HR** Lüks Oval Danışma Bankosu 15



**HR** Lüks Oval Danışma Bankosu 16



**HR** Lüks L Danışma Bankosu 17

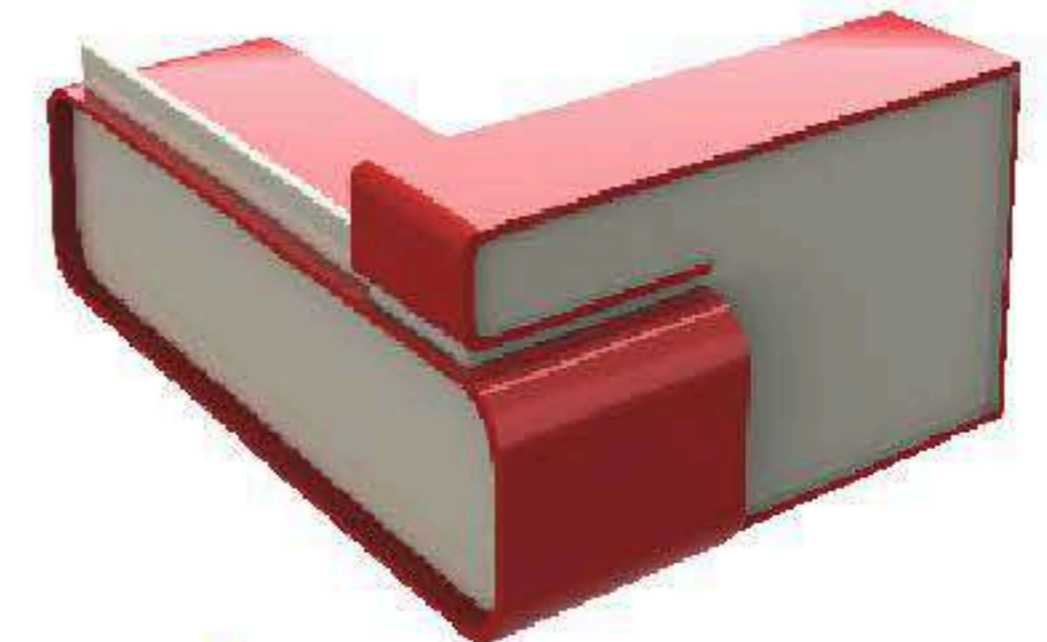

**HR** Lüks L Danışma Bankosu 18



**HR** 40x40x180 cm Vitrin



**HR** 40x80x180 cm Vitrin



**HR** 40x40x180 cm Vitrin



**HR** Alüminyum Banko 90 cm. veya 120 cm.



**HR** 40x80x180 cm Vitrin



**HR** 40x40x180 cm Vitrin



**HR** Cam Raf Uygulama 01



**HR** Cam Raf Uygulama 02



**HR** Cam Raf Uygulama 03



**HR** Cam Raf Uygulama 04



**HR** Cam Raf Uygulama 05



**HR** Cam Raf Uygulama 06



**HR** Cam Raf Uygulama 07



**HR** Cam Raf Uygulama 08



Cam Masa 01



Cam Masa 02



Cam Masa 03



Cam Masa 04



Cam Masa 05



Cam Masa 06



Cam Masa 07



Cam Masa 08



Cam Masa 09



Cam Masa 10



Cam Masa 11



Cam Masa 12



Ahşap Şapkalı Duvar Ünitesi



Ahşap Şapkasız Duvar Ünitesi



Ahşap Oval Şapkalı Duvar Ünitesi



Ahşap Şapkalı Tekstil Ünitesi - A



Ahşap Şapkalı Kanallı Pano Ünitesi



Ahşap Şapkasız Kanallı Pano Ünitesi



Ahşap Oval Şapkalı Kanallı Pano Ünitesi



Ahşap Şapkalı Tekstil Ünitesi-B



Ahşap Şapkalı Züccaciye Ünitesi



Suntalam Lüks 120 cm. Çekmeceli Banko

Alüminyum 140 cm. Çekmeceli Banko



Suntalam 160 cm. Çekmeceli Banko



Alüminyum 100 cm. Banko



Ahşap Çift Yönlü Orta Ünitesi



Ahşap Çift Yönlü Kanallı Pano Orta Ünitesi



Ahşap Çift Yönlü Tekstil Ünitesi - A



Ahşap Çift Yönlü Tekstil Ünitesi - B



Ahşap Çiftli Orta Reyon



Ahşap Ünite



Ahşap Uygulama



Ahşap Tek Yönlü Orta Ünitesi



Ahşap Tek Yönlü Kanallı Pano Orta Ünitesi



Ahşap Tek Yönlü Ayakkabı Orta Ünitesi



Ahşap Tek Yönlü Züccaciye Orta Ünitesi



Ahşap Uygulama



Zerox Sistemi Uygulama



Ahşap Uygulama



Suntalam Lüks Banko



Suntalam Banko  
100 - 120 - 140 - 160 - 180 cm.



Ahşap Çift Yönlü Züccaciye Orta Ünitesi



Suntalam Banko



Ahşap Uygulama





HR Kanallı Pano Uygulama



HR Konik Dikme Uygulama



HR Rondo Sistemi Uygulama



HR Ahşap Kare Dikme Uygulama



HR 40x40 Kare Dikme



HR Konik Dikme



HR Zigon Sehpa



HR Kombine Orta Stand



HR Pramit Stand



HR 30x30 F Dikme Uygulama



HR 25x25 Kare Stand Uygulama





HR Konik Dikme Uygulama



HR Konik Dikme Uygulama



HR Telli Model

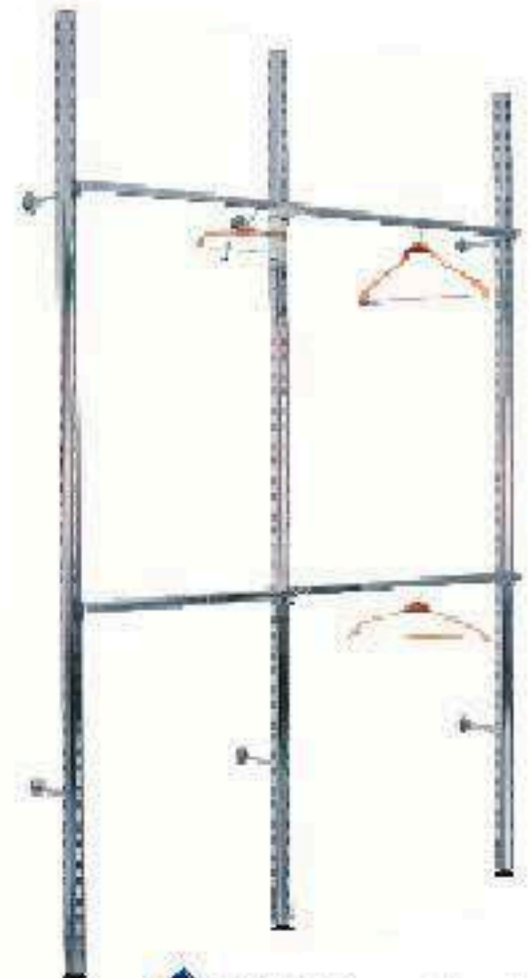

HR Optik Reyon Uygulama



HR 30x30 F Dikme Uygulama 2



HR Telli Model 2



HR Optik Reyon Uygulama 2



HR 40x40 Kare Dikme 2



HR 30x30 F Dikme Uygulama 3



HR 40x40 Kare Dikme 3

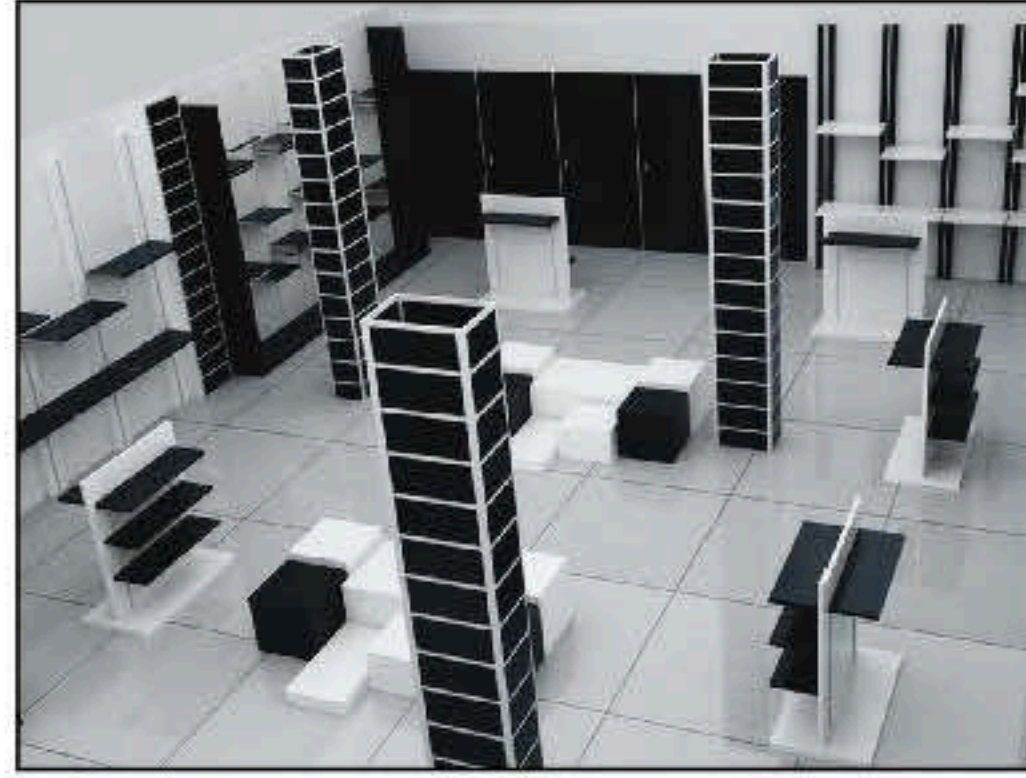
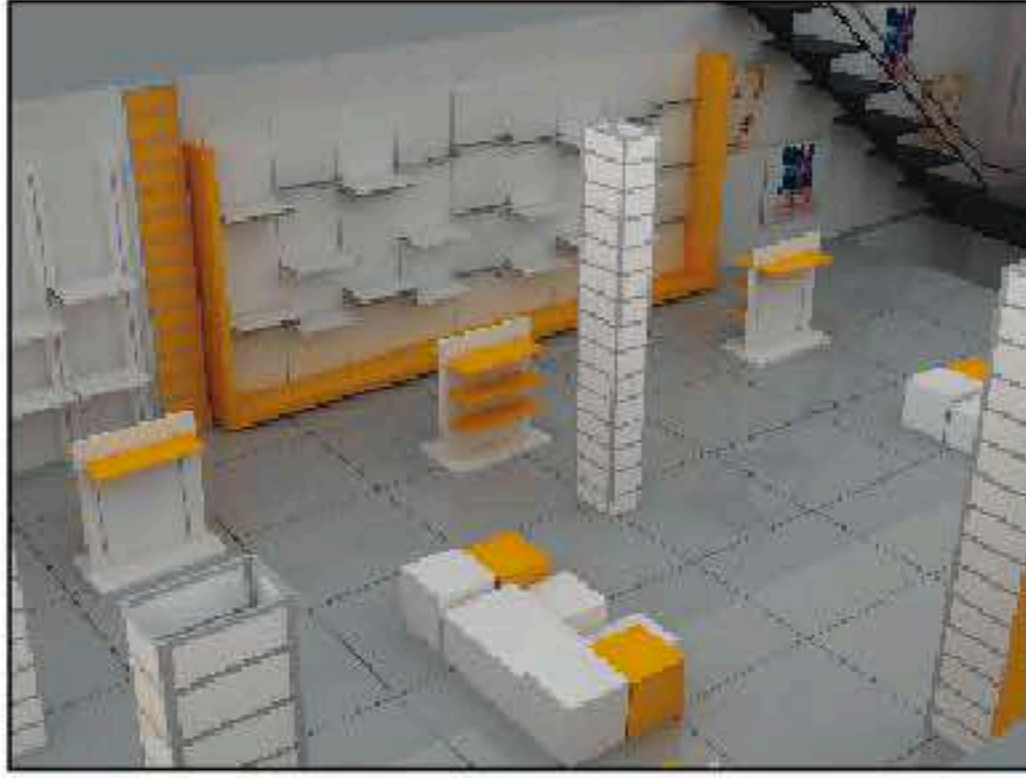

HR Ahşap 10x10 Kare Dikme

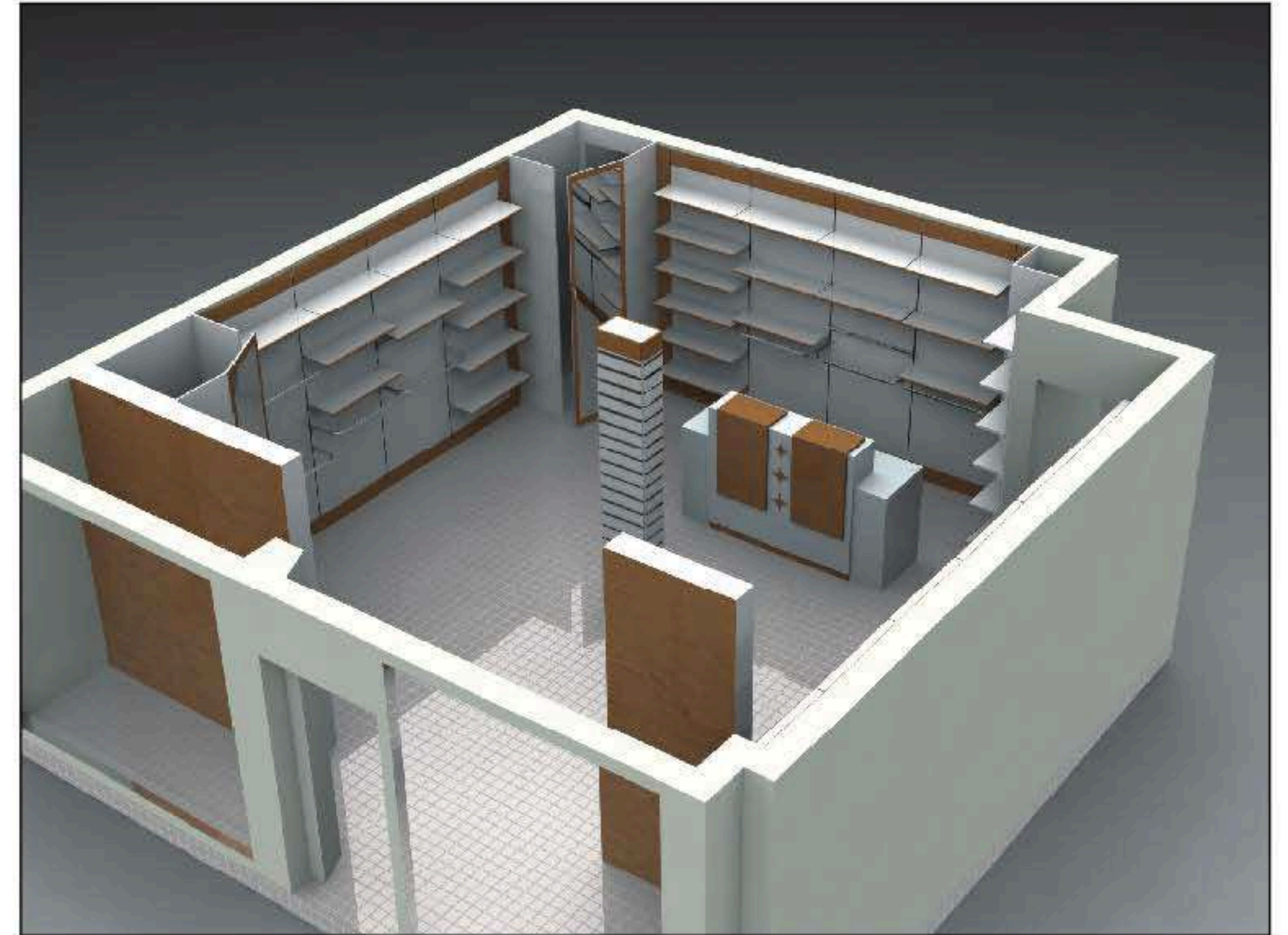
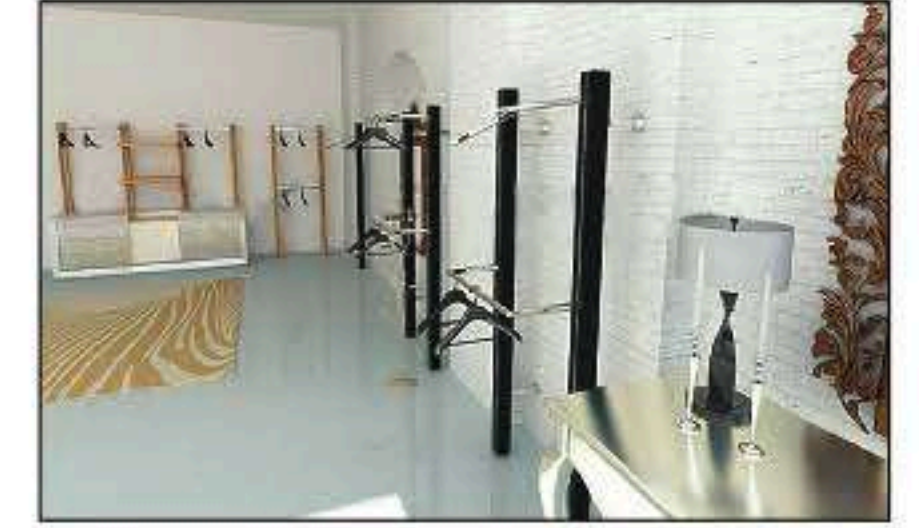

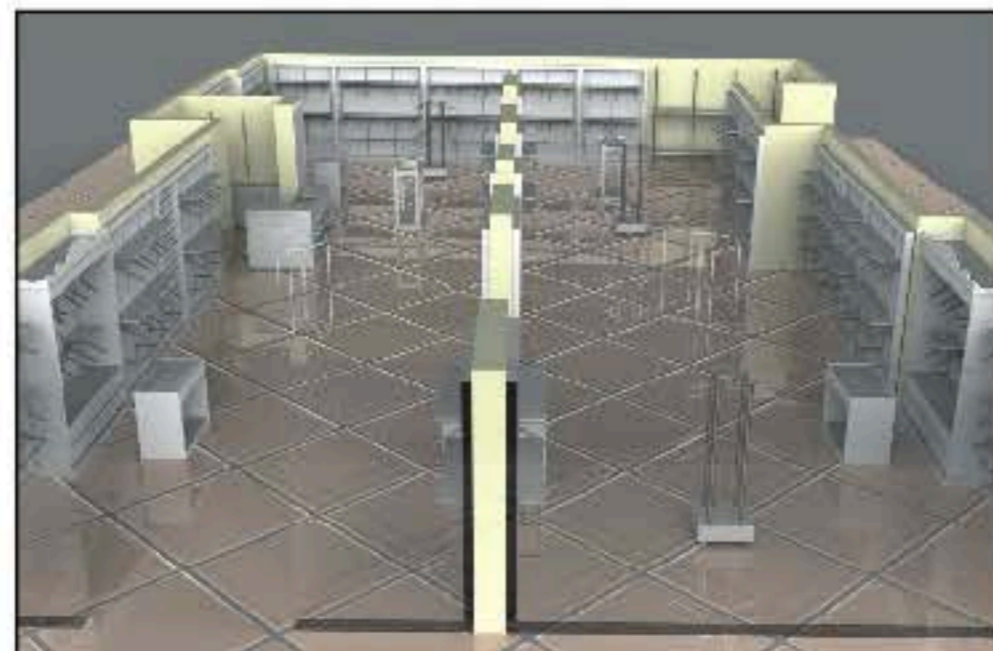
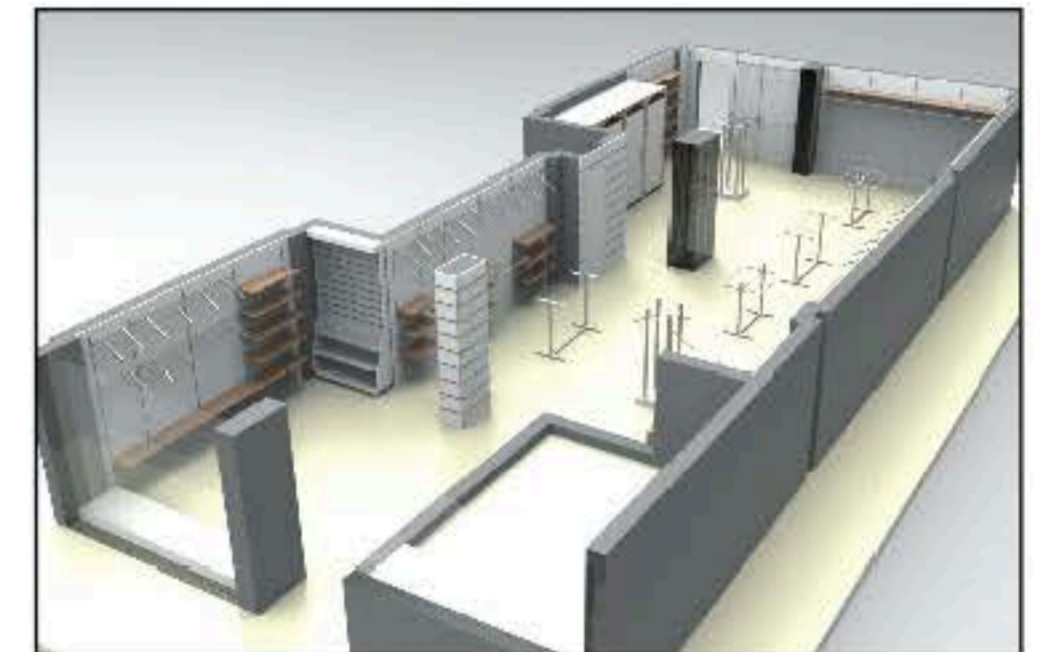
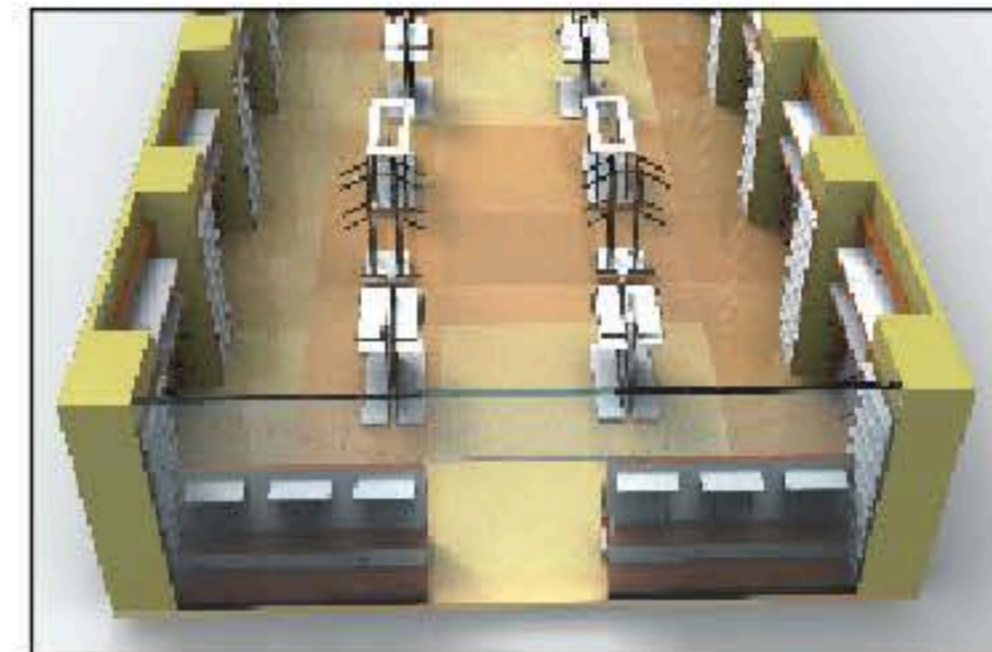
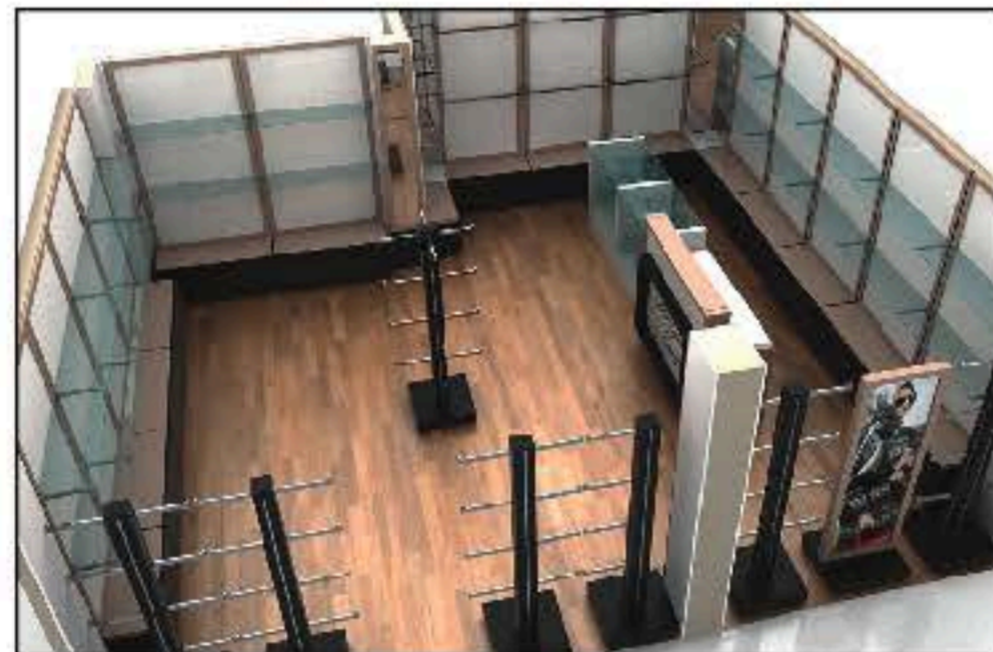
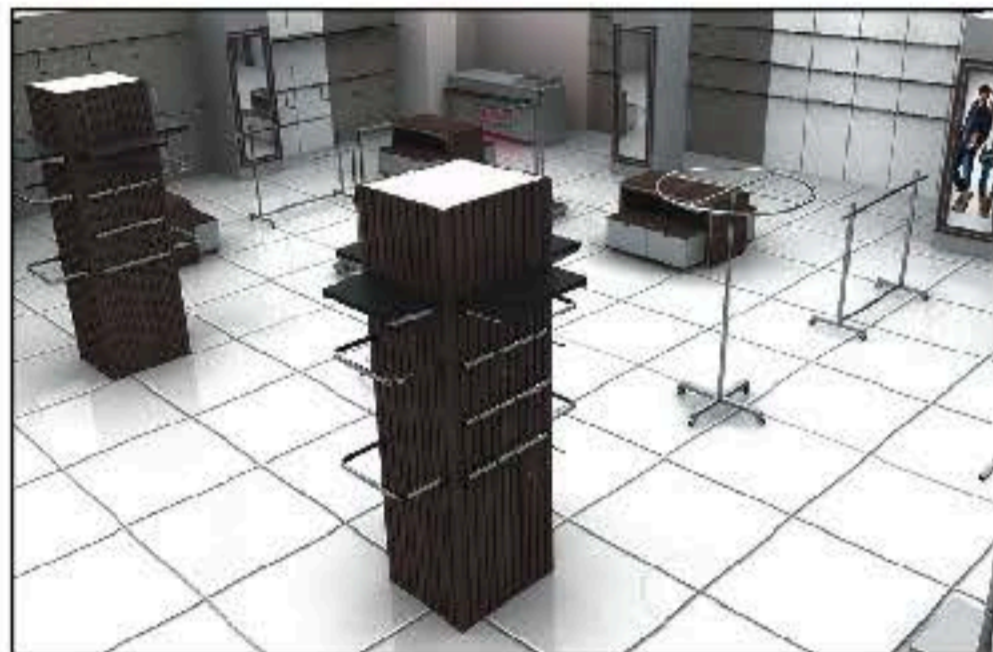
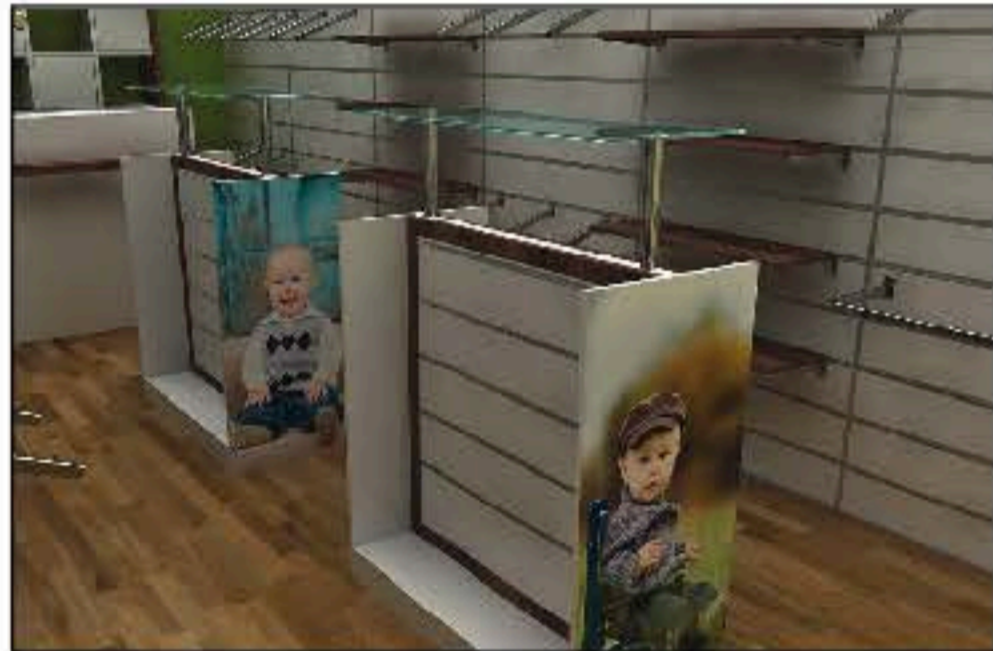
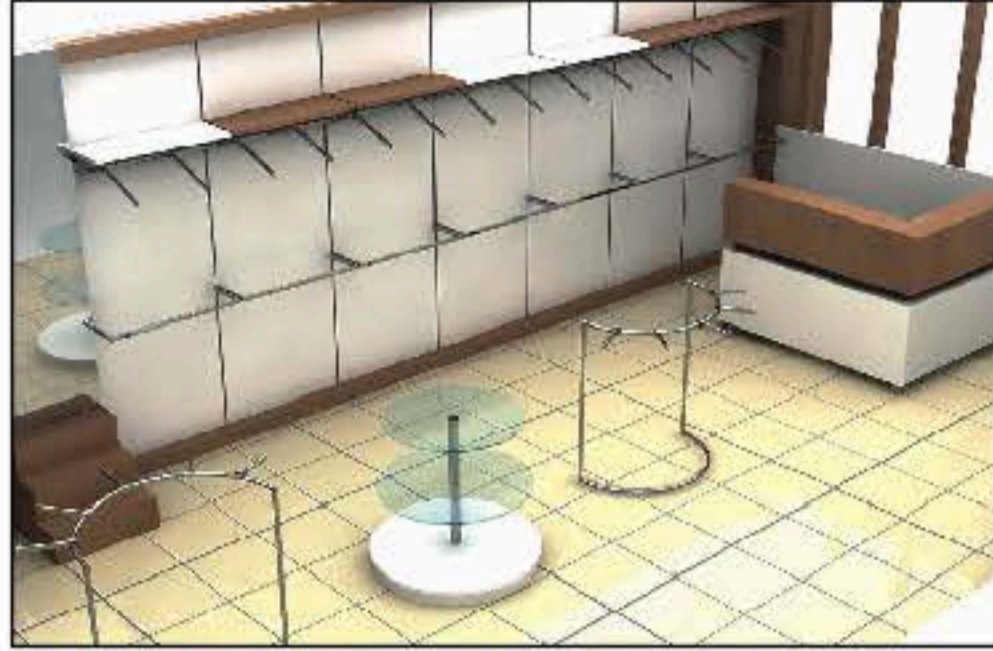





**Katlanır Lüks Tekli Askılık 01**



**Lüks Ufi Stand 02**



**Lüks Döner Helezon 03**



**Katlanır Lüks Çift Katlı Askılık 04**



**Optik Reyon 05**



**Lüks Ufi Stand 06**



**Lüks Döner Daire 07**



**Lüks Helezon Stand 08**



**Optik Stand 09**



**Lüks Ahtapot Stand 10**



**Lüks Ahtapot Stand 11**



**10x30 Çiftli Lüks Stand 12**



**10x30 Tekli Lüks Stand 13**



**Süper Tekli Lüks Stand 14**



**Lüks Ahtapot Stand 15**



**Lüks Ahtapot Stand 16**

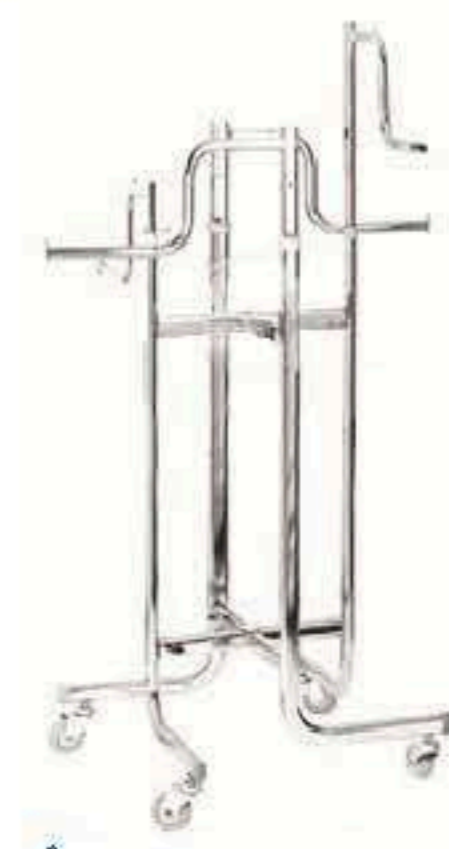

**Lüks Ahtapot Stand 17**



**Lüks Ahtapot Stand 18**



**Lüks 8 Kollu Ufi Stand 19**



**Lüks Ahtapot Stand 20**



**Lüks Optik Reyon 21**



Lüks Çift Yönlü Orta Stand 22



Lüks Ahtapot Stand 23



Lüks C Stand 24



Lüks Yuvarlak Stand 25



Lüks S Stand 26



Lüks Kum Saati Stand 27



Lüks Gömleklik 28

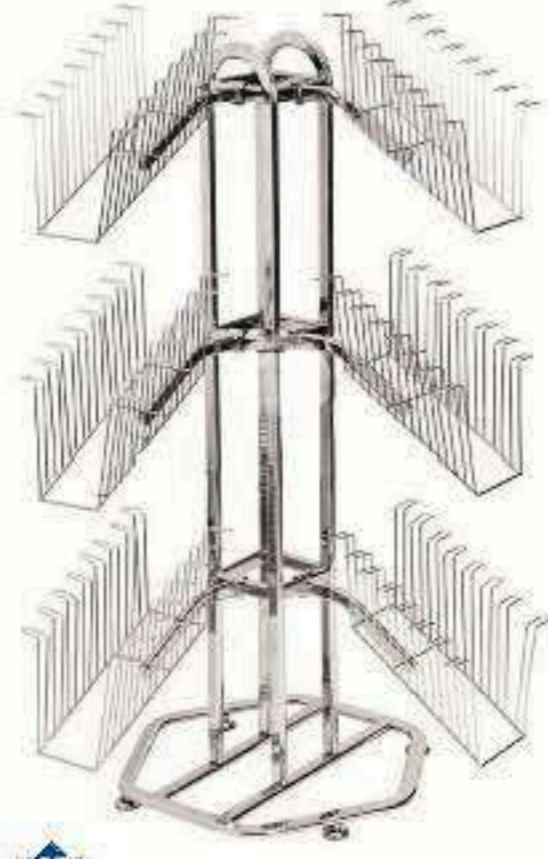

Lüks Gömleklik 29



Lüks Optik Reyon 30



Zigon Sehpa 31



4 Taraflı Orta Stand 32



Suntalem Yuvarlak Orta Stand 33



Süper Tekli Stand 34



Süper Çift Katlı Stand 35



Süper Tekli Stand Bastonlu 36

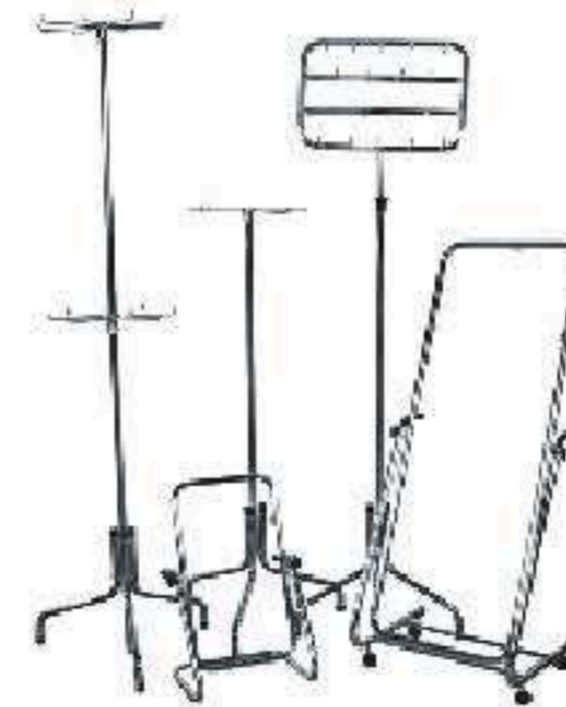

Gravatlık 37



Ahşap Tekli Stand 38



Ahşap Çiftli Stand 39



**HR** Tekli Askılık 40



**HR** Döner Helezon 41



**HR** Döner Daire 42



**HR** Ufi Stand 43



**HR** Çift Katlı Askılık 44



**HR** V Stand 45



**HR** 90x190 Pano Stand 46



**HR** Katlanır Havuz Sepet 47



**HR** 60x80 Metal Ayaklı Havuz Sepet 48



**HR** Tel Ayakkabılık 49



**HR** Puf 50



**HR** 60x90 Metal Ayaklı Havuz Sepet 51



**HR** Battal Havuz Sepet 52



**HR** 60x90 Battal Havuz Sepet 53



**HR** 60x90 Battal Havuz Sepet 54



**HR** Ten rengi manken



**HR** Beyaz manken



**HR** Siyah manken



**HR** Ten rengi manken



**HR** Terzi mankeni



**HR** Pantolonluk



**HR** Yarım manken



**HR** Yarım manken



**HR** Çoraplık ayak



**HR** Çocuk mankeni



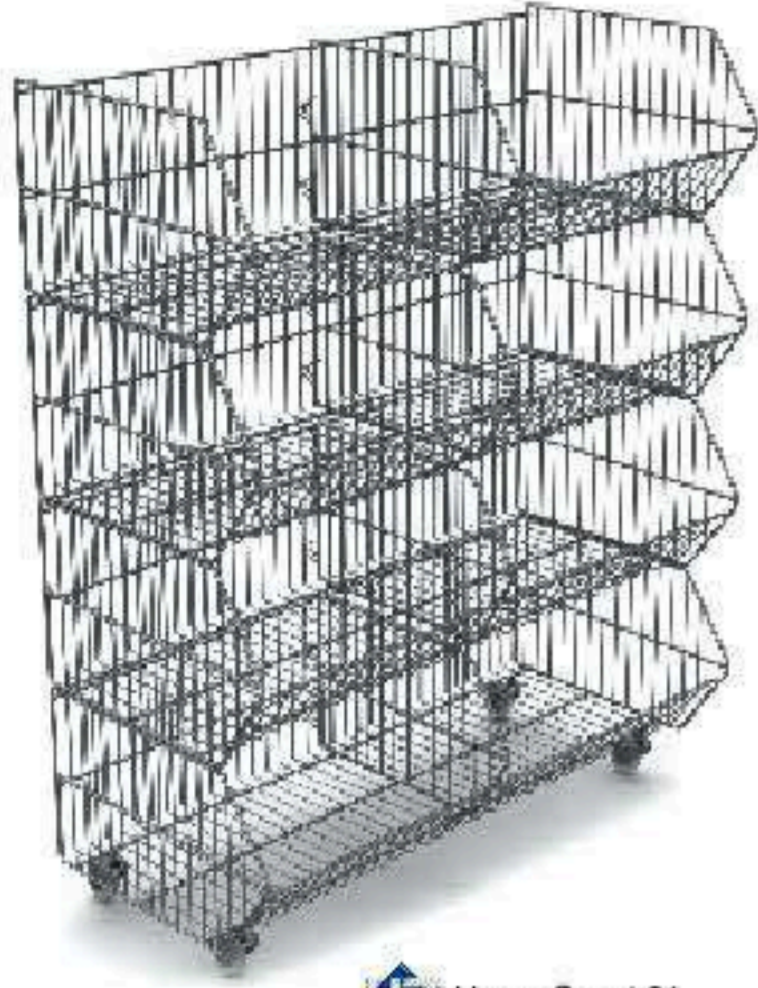

Havuz Sepet 01



Yük Taşıma Arabası 02



Suntalem Raf Uygulama 05



Ara Bağlantı 03

Kanca 04

Cam Raf Kolu 06

Destek Grubu 08



Ters Raf Kolu 07



Suntalem Profil 09



Market Raf Ayakları 10



Market Raf Destek 11



Kanallı Raf Desteği 12

Suntalem Profil



AB 1 Kanca 13



AB 1 Baston 14

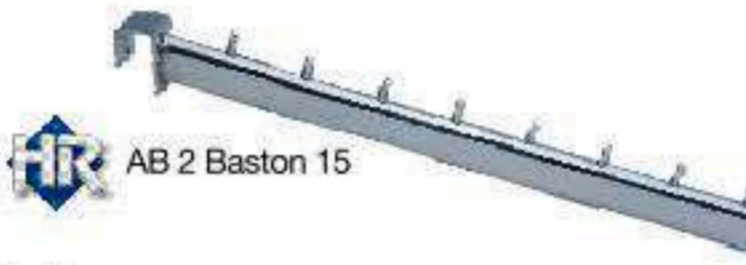

AB 2 Baston 15

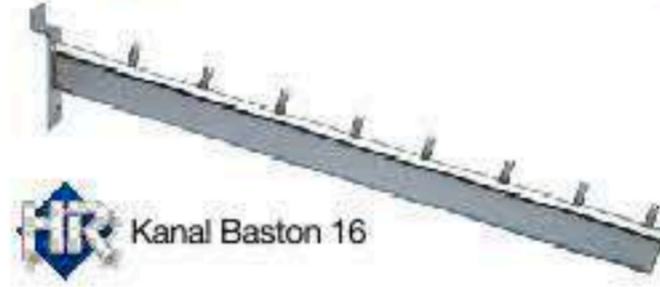

Kanal Baston 16



UB 2 60-90-120 cm. 17



UB 1 60-90-120 cm. 18

Kanala Geçen UB 160-90-120 cm. 19



Cam Raf Kolu 20



Ters Raf Kolu 21



Kanca 32



Kanca 10-15-20-25 cm. 31

Kanca 20 cm. 29

Destek 30

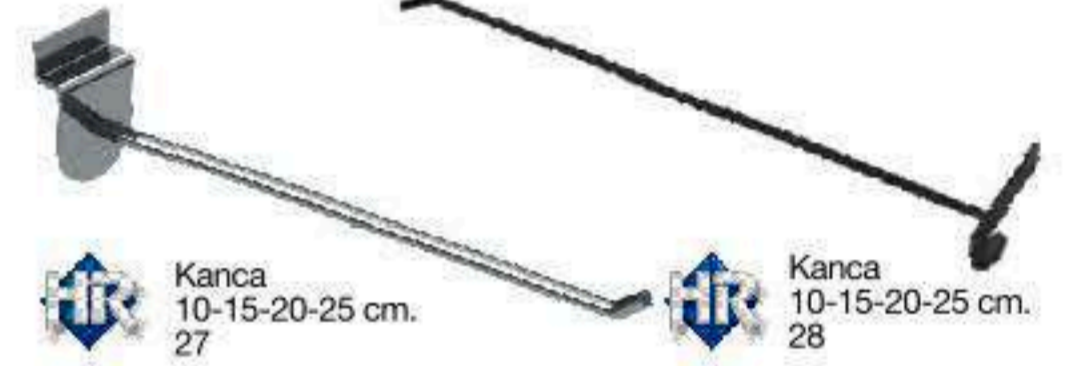

Kanca 10-15-20-25 cm. 27

Kanca 10-15-20-25 cm. 28



U Kabin Borusu 25



Kanal Pano Topluk 26



Düz Raf Kolu 23



Kanal Pano Topluk 24



AB 1 60-90-120 cm. 22



**HR** Kompakt Arşivleme Dolabı



**HR** İkili Ranza



**HR** 4'lü Klasör Dolabı



**HR** 3'lü Klasör Dolabı



**HR** 2'lü Klasör Dolabı



**HR** Tekli Ranza



**HR** Dosya Dolabı 198 cm



**HR** Dosya Dolabı 100 cm



**HR** Dosya Dolabı 130 cm



**HR** Tekli Soyunma Dolabı



**HR** 2'li Soyunma Dolabı



**HR** Ekonomik 2'li Soyunma Dolabı



**HR** 3'lü Soyunma Dolabı



**HR** 4'lü Soyunma Dolabı



**HR** 6'lü Soyunma Dolabı



**HR** 5'li Öğretmen Dolabı



**HR** 10'lü Öğretmen Dolabı



**HR** Demonte Tekli Soyunma Dolabı

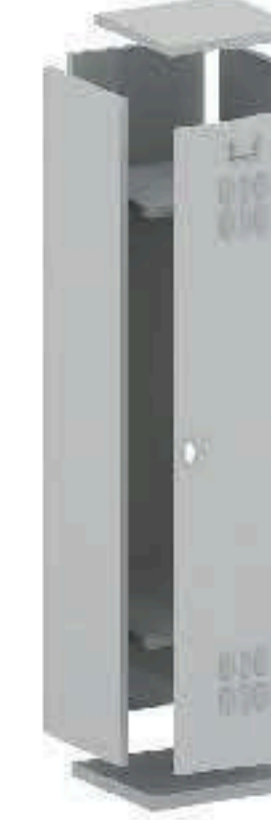

**HR** Demonte 2'li Soyunma Dolabı

